

▶ BPS551020M  
BPS551220M

EN User Manual  
Oven

# USER MANUAL

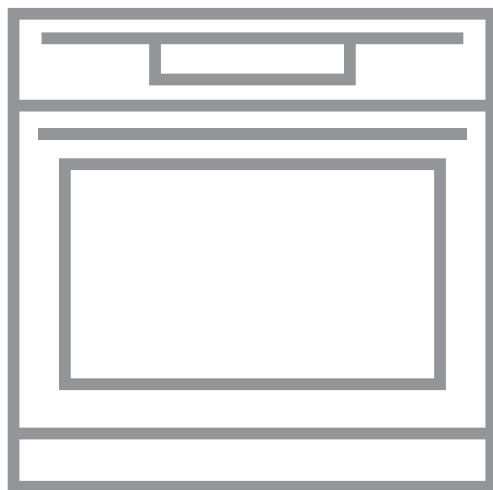

**AEG**

# CONTENTS

1. SAFETY INFORMATION.....	2
2. SAFETY INSTRUCTIONS.....	4
3. PRODUCT DESCRIPTION.....	7
4. BEFORE FIRST USE.....	8
5. DAILY USE.....	8
6. CLOCK FUNCTIONS.....	11
7. USING THE ACCESSORIES.....	13
8. ADDITIONAL FUNCTIONS.....	14
9. HINTS AND TIPS.....	15
10. CARE AND CLEANING.....	29
11. TROUBLESHOOTING.....	32
12. ENERGY EFFICIENCY.....	35

## FOR PERFECT RESULTS

Thank you for choosing this AEG product. We have created it to give you impeccable performance for many years, with innovative technologies that help make life simpler features you might not find on ordinary appliances. Please spend a few minutes reading to get the very best from it.

Visit our website for:



Get usage advice, brochures, trouble shooter, service information:  
**[www.aeg.com/webselfservice](http://www.aeg.com/webselfservice)**



Register your product for better service:  
**[www.registeraeg.com](http://www.registeraeg.com)**



Buy Accessories, Consumables and Original spare parts for your appliance:  
**[www.aeg.com/shop](http://www.aeg.com/shop)**

## CUSTOMER CARE AND SERVICE

Always use original spare parts.

When contacting our Authorised Service Centre, ensure that you have the following data available: Model, PNC, Serial Number.

The information can be found on the rating plate.

 Warning / Caution-Safety information

 General information and tips

 Environmental information

Subject to change without notice.

### 1. SAFETY INFORMATION

Before the installation and use of the appliance, carefully read the supplied instructions. The manufacturer is not responsible for any injuries or

damages that are the result of incorrect installation or usage. Always keep the instructions in a safe and accessible location for future reference.

## 1.1 Children and vulnerable people safety

- This appliance can be used by children aged from 8 years and above and persons with reduced physical, sensory or mental capabilities or lack of experience and knowledge if they have been given supervision or instruction concerning the use of the appliance in a safe way and understand the hazards involved.
- Do not let children play with the appliance.
- Keep all packaging away from children and dispose of it appropriately.
- Keep children and pets away from the appliance when it operates or when it cools down. Accessible parts are hot.
- If the appliance has a child safety device, this should be activated.
- Children shall not carry out cleaning and user maintenance of the appliance without supervision.
- Children aged 3 years and under must be kept away from this appliance when it is in operation at all times.

## 1.2 General Safety

- Only a qualified person must install this appliance and replace the cable.
- **WARNING:** The appliance and its accessible parts become hot during use. Care should be taken to avoid touching heating elements. Children less than 8 years of age shall be kept away unless continuously supervised.
- Always use oven gloves to remove or put in accessories or ovenware.
- Before carrying out any maintenance, disconnect the appliance from the power supply.

- Ensure that the appliance is switched off before replacing the lamp to avoid the possibility of electric shock.
- Do not use a steam cleaner to clean the appliance.
- Do not use harsh abrasive cleaners or sharp metal scrapers to clean the glass door since they can scratch the surface, which may result in shattering of the glass.
- If the mains power supply cable is damaged, it must be replaced by the manufacturer, its Authorised Service Centre or similarly qualified persons to avoid an electrical hazard.
- Excessive spillage must be removed before the pyrolytic cleaning. Remove all parts from the oven.
- To remove the shelf supports first pull the front of the shelf support and then the rear end away from the side walls. Install the shelf supports in the opposite sequence.
- The means for disconnection must be incorporated in the fixed wiring in accordance with the wiring rules.

## 2. SAFETY INSTRUCTIONS

### 2.1 Installation



#### **WARNING!**

Only a qualified person must install this appliance.

- Remove all the packaging.
- Do not install or use a damaged appliance.
- Follow the installation instruction supplied with the appliance.
- Always take care when moving the appliance as it is heavy. Always use safety gloves and enclosed footwear.
- Do not pull the appliance by the handle.
- Keep the minimum distance from the other appliances and units.
- Make sure that the appliance is installed below and adjacent safe structures.
- The sides of the appliance must stay adjacent to appliances or to units with the same height.

- The appliance is equipped with an electric cooling system. It must be operated with the electric power supply.

### 2.2 Electrical connection



#### **WARNING!**

Risk of fire and electrical shock.

- All electrical connections should be made by a qualified electrician.
- The appliance must be earthed.
- Make sure that the parameters on the rating plate are compatible with the electrical ratings of the mains power supply.
- Always use a correctly installed shockproof socket.
- Do not use multi-plug adapters and extension cables.
- Make sure not to cause damage to the mains plug and to the mains cable. Should the mains cable need

to be replaced, this must be carried out by our Authorised Service Centre.

- Do not let mains cables touch or come near the appliance door, especially when the door is hot.
- The shock protection of live and insulated parts must be fastened in such a way that it cannot be removed without tools.
- Connect the mains plug to the mains socket only at the end of the installation. Make sure that there is access to the mains plug after the installation.
- If the mains socket is loose, do not connect the mains plug.
- Do not pull the mains cable to disconnect the appliance. Always pull the mains plug.
- Use only correct isolation devices: line protecting cut-outs, fuses (screw type fuses removed from the holder), earth leakage trips and contactors.
- The electrical installation must have an isolation device which lets you disconnect the appliance from the mains at all poles. The isolation device must have a contact opening width of minimum 3 mm.
- This appliance complies with the E.E.C. Directives.

### 2.3 Use



#### **WARNING!**

Risk of injury, burns and electrical shock or explosion.

- This appliance is for household use only.
- Do not change the specification of this appliance.
- Make sure that the ventilation openings are not blocked.
- Do not let the appliance stay unattended during operation.
- Deactivate the appliance after each use.
- Be careful when you open the appliance door while the appliance is in operation. Hot air can release.
- Do not operate the appliance with wet hands or when it has contact with water.
- Do not apply pressure on the open door.

- Do not use the appliance as a work surface or as a storage surface.
- Open the appliance door carefully. The use of ingredients with alcohol can cause a mixture of alcohol and air.
- Do not let sparks or open flames to come in contact with the appliance when you open the door.
- Do not put flammable products or items that are wet with flammable products in, near or on the appliance.



#### **WARNING!**

Risk of damage to the appliance.

- To prevent damage or discoloration to the enamel:
  - do not put ovenware or other objects in the appliance directly on the bottom.
  - do not put aluminium foil directly on the bottom of cavity of the appliance.
  - do not put water directly into the hot appliance.
  - do not keep moist dishes and food in the appliance after you finish the cooking.
  - be careful when you remove or install the accessories.
- Discoloration of the enamel or stainless steel has no effect on the performance of the appliance.
- Use a deep pan for moist cakes. Fruit juices cause stains that can be permanent.
- This appliance is for cooking purposes only. It must not be used for other purposes, for example room heating.
- Always cook with the oven door closed.
- If the appliance is installed behind a furniture panel (e.g. a door) make sure the door is never closed when the appliance is in operation. Heat and moisture can build up behind a closed furniture panel and cause subsequent damage to the appliance, the housing unit or the floor. Do not close the furniture panel until the appliance has cooled down completely after use.

## 2.4 Care and cleaning



### WARNING!

Risk of injury, fire, or damage to the appliance.

- Before maintenance, deactivate the appliance and disconnect the mains plug from the mains socket.
- Make sure the appliance is cold. There is the risk that the glass panels can break.
- Replace immediately the door glass panels when they are damaged. Contact the Authorised Service Centre.
- Be careful when you remove the door from the appliance. The door is heavy!
- Clean regularly the appliance to prevent the deterioration of the surface material.
- Clean the appliance with a moist soft cloth. Only use neutral detergents. Do not use any abrasive products, abrasive cleaning pads, solvents or metal objects.
- If you use an oven spray, follow the safety instruction on it's packaging.
- Do not clean the catalytic enamel (if applicable) with any kind of detergent.

## 2.5 Pyrolytic cleaning



### WARNING!

Risk of Injury / Fires / Chemical Emissions (Fumes) in Pyrolytic Mode.

Do not start the Pyrolysis if the Plus Steam button is pressed in.

- Before carrying out a Pyrolytic self-cleaning function or the First Use please remove from the oven cavity:
  - any excess food residues, oil or grease spills / deposits.
  - any removable objects (including shelves, side rails etc., provided with the product) particularly any non-stick pots, pans, trays, utensils etc.
- Read carefully all the instructions for Pyrolytic cleaning.

- Keep children away from the appliance while the Pyrolytic cleaning is in operation. The appliance becomes very hot and hot air is released from the front cooling vents.
- Pyrolytic cleaning is a high temperature operation that can release fumes from cooking residues and construction materials, as such consumers are strongly advised to:
  - provide good ventilation during and after each Pyrolytic cleaning.
  - provide good ventilation during and after the first use at maximum temperature operation.
- Unlike all humans, some birds and reptiles can be extremely sensitive to potential fumes emitted during the cleaning process of all Pyrolytic Ovens.
  - Remove any pets (especially birds) from the vicinity of the appliance location during and after the Pyrolytic cleaning and first use maximum temperature operation to a well ventilated area.
- Small pets can also be highly sensitive to the localized temperature changes in the vicinity of all Pyrolytic Ovens when the Pyrolytic self cleaning program is in operation.
- Non-stick surfaces on pots, pans, trays, utensils etc., can be damaged by the high temperature Pyrolytic cleaning operation of all Pyrolytic Ovens and can be also a source for low level harmful fumes.
- Fumes released from all Pyrolytic Ovens / Cooking Residues as described are not harmful to humans, including infants or persons with medical conditions.

## 2.6 Internal light



### WARNING!

Risk of electrical shock.

- The type of light bulb or halogen lamp used for this appliance is only for household appliances. Do not use it for house lighting.
- Before replacing the lamp, disconnect the appliance from the power supply.

- Only use lamps with the same specifications.

## 2.7 Disposal



**WARNING!**  
Risk of injury or suffocation.

- Disconnect the appliance from the mains supply.
- Cut off the mains electrical cable close to the appliance and dispose of it.

- Remove the door catch to prevent children or pets from becoming trapped in the appliance.

## 2.8 Service

- To repair the appliance contact an Authorised Service Centre.
- Use original spare parts only.

# 3. PRODUCT DESCRIPTION

## 3.1 General overview

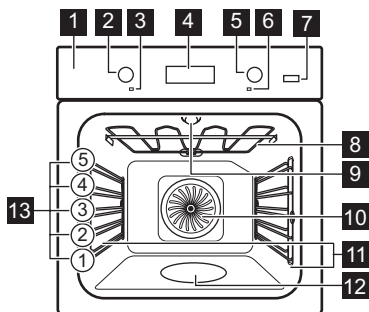

- 1** Control panel
- 2** Knob for the oven functions
- 3** Power lamp / symbol
- 4** Electronic programmer
- 5** Knob for the temperature
- 6** Temperature indicator / symbol
- 7** Plus Steam button
- 8** Heating element
- 9** Lamp
- 10** Fan
- 11** Shelf support, removable
- 12** Cavity embossment
- 13** Shelf positions

## 3.2 Accessories

### Wire shelf

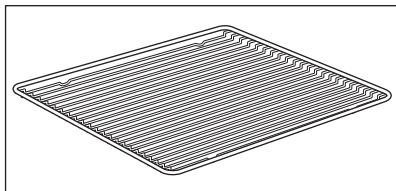

For cookware, cake tins, roasts.

### Grill- / Roasting pan

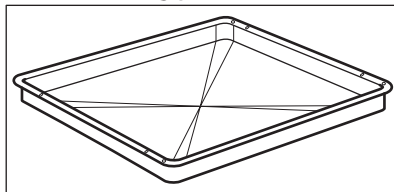

To bake and roast or as a pan to collect fat.

Trivet

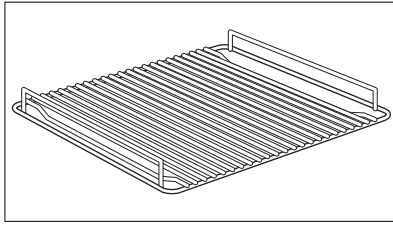

For roasting and grilling.

**i** Use the trivet only with the Grill- / Roasting pan.

## 4. BEFORE FIRST USE

**!** **WARNING!**  
Refer to Safety chapters.

**i** To set the Time of day refer to "Clock functions" chapter.

### 4.1 Initial Cleaning

Remove all accessories and removable shelf supports from the oven.

**i** Refer to "Care and cleaning" chapter.

Clean the oven and the accessories before first use.

Put the accessories and the removable shelf supports back to their initial position.

## 5. DAILY USE

**!** **WARNING!**  
Refer to Safety chapters.

### 5.1 Retractable knobs

To use the appliance, press the control knob. The control knob comes out.

### 5.2 Activating and deactivating the appliance













**i** **It depends on the model if your appliance has lamps, knob symbols or indicators:**

- The lamp turns on when the appliance operates.
- The symbol shows whether the knob controls the oven functions or the temperature.
- The indicator turns on when the oven heats up.

1. Turn the knob for the oven functions to select an oven function.
2. Turn the knob for the temperature to select a temperature.
3. To deactivate the appliance, turn the knobs for the oven functions and temperature to the off position.



### 5.3 Oven functions

Oven function	Application
 Off position	The appliance is off.
 Fast Heat Up	To decrease the heat-up time.
 True Fan Cooking	To bake on up to three shelf positions at the same time and to dry food. Set the temperature 20 - 40 °C lower than for Top / Bottom Heat.
 True Fan Cooking PLUS	To add humidity during the cooking. To get the right colour and crispy crust during baking. To give more juiciness during reheating.
 Pizza Setting	To bake food on one shelf position for a more intensive browning and a crispy bottom. Set the temperature 20 - 40 °C lower than for Top / Bottom Heat.
 Conventional Cooking (Top / Bottom Heat)	To bake and roast food on one shelf position.
 Bottom Heat	To bake cakes with crispy bottom and to preserve food.
 Defrost	This function can be used for defrosting frozen foods, such as vegetables and fruits. The defrosting time depends on the amount and size of the frozen food.
 Moist Fan Baking	To bake breads, cakes and cookies. To save energy during cooking. This function must be used in accordance with the Moist Fan Baking table in order to achieve the desired cooking result. To get more information about the recommended settings, refer to the Hints and Tips chapter, Moist Fan Baking table. This function was used to define the energy efficiency class acc. to EN 60350-1.
 Grilling	To grill flat food and to toast bread.
 Turbo Grilling	To roast larger meat joints or poultry with bones on one shelf position. Also to make gratins and to brown.
 Pyrolysis	To activate the automatic pyrolytic cleaning of the oven. This function burns off residual dirt in the oven.

-  The lamp may automatically deactivate at a temperature below 60 °C during some oven functions.

## 5.4 Activating the True Fan Cooking PLUS function



This function allows to have an improvement of humidity during the cooking.

-  **WARNING!** Risk of burns and damage to the appliance.

Released humidity can cause burns:

- Do not open the appliance door when the function True Fan Cooking PLUS operates, with the exception of preheating.
- Open the appliance door with care after the True Fan Cooking PLUS function stops.

-  Refer to "Hints and tips" chapter.

1. Open the oven door.
2. Fill the cavity embossment with tap water.  
The maximum capacity of the cavity embossment is 250 ml.  
Fill the cavity embossment with water only when the oven is cold.
3. Put food in the appliance and close the oven door.
4. Set the True Fan Cooking PLUS function: .
5. Press the Plus Steam button .  
The Plus Steam button works only with the True Fan Cooking PLUS function.

The indicator turns on.

6. Turn the knob for the temperature to select a temperature.

-  **CAUTION!** Do not refill the cavity embossment with water during cooking or when the oven is hot.

7. To deactivate the appliance, press the Plus Steam button , turn the knobs for the oven functions and temperature to the off position. The indicator of the Plus Steam button turns off.

8. Remove water from the cavity embossment.

-  **WARNING!** Make sure that the appliance is cool before you remove the remaining water from the cavity embossment.

## 5.5 Fast heat up function

The fast heat up function decreases the heat up time.

-  Do not put food in the oven when the Fast heat up function operates.

1. Set the fast heat up function. Refer to the Oven functions table.
2. Turn the knob for the temperature to set the temperature.  
An acoustic signal sounds when the appliance is at the set temperature.

-  The fast heat up function does not deactivate after the acoustic signal. You must deactivate the function manually.

3. Set an oven function.

## 5.6 Display

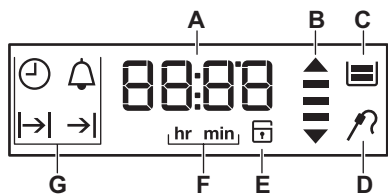

- A. Timer
- B. Heat-up and residual heat indicator
- C. Water drawer (selected models only)
- D. Core temperature sensor (selected models only)
- E. Door lock (selected models only)
- F. Hours / minutes
- G. Clock functions

## 5.7 Buttons

Button	Function	Description
	CLOCK	To set a clock function.
	MINUS	To set the time.
	MINUTE MINDER	To set the MINUTE MINDER. Hold the button for more than 3 seconds to activate or deactivate the oven lamp.
	PLUS	To set the time.
	TEMPERATURE	To check the oven temperature or the temperature of the core temperature sensor (if applicable). Use only while an oven function is in operation.
	Plus Steam	To activate the True Fan Cooking PLUS function.

## 5.8 Heat-up indicator



When you activate an oven function, the bars in the display come on one by

one. The bars show that the oven temperature increases or decreases.

# 6. CLOCK FUNCTIONS

## 6.1 Clock functions table

Clock function	Application
TIME OF DAY	To show or change the time of day. You can change the time of day only when the appliance is off.
DURATION	To set how long the appliance operates. Use only when an oven function is set.
END	To set when the appliance deactivates. Use only when an oven function is set.

Clock function	Application
 TIME DELAY	Combination of DURATION and END function.
 MINUTE MINDER	Use to set a countdown time. This function has no effect on the operation of the appliance. You can set the MINUTE MINDER at any time, also if the appliance is off.
<b>00:00</b> COUNT UP TIMER	If you do not set any other clock function the COUNT UP TIMER automatically monitor how long the appliance operates. It is on immediately when the oven starts to heat. The Count Up Timer cannot be used with the functions: DURATION, END.

## 6.2 Setting and changing the time



After the first connection to the mains, wait until the display shows **hr** and "12:00". "12" flashes.

1. Press **+** or **-** to set the hours.
2. Press  to confirm and switch to set the minutes.



The display shows **min** and the set hour. "00" flashes.

3. Press **+** or **-** to set the current minutes.
4. Press  to confirm or the set time of day will be saved automatically after 5 seconds.

The display shows the new time.

To change the time of day press  again and again until the indicator for the time of day  flashes in the display.





## 6.3 Setting the DURATION

1. Set an oven function.
2. Press  again and again until  starts to flash.
3. Press **+** or **-** to set the minutes and the hours for DURATION time.
4. Press  to confirm.





When the time ends an acoustic signal sounds for 2 minutes.  and time setting flash in the display. The appliance deactivates automatically.

5. Press any button to stop the acoustic signal.
6. Turn the knob for the oven functions to the off position.

## 6.4 Setting the END

1. Set an oven function.
2. Press  again and again until  starts to flash.
3. Press **+** or **-** to set the hours and the minutes for END time.
4. Press  to confirm.  
At the set time an acoustic signal sounds for 2 minutes.  and time setting flash in the display. The appliance deactivates automatically.
5. Press any button to stop the acoustic signal.
6. Turn the knob for the oven functions to the off position.

## 6.5 Setting the TIME DELAY function





1. Set an oven function.
2. Press  again and again until  starts to flash.
3. Press **+** or **-** to set the minutes and the hours for DURATION time.
4. Press  to confirm. The display shows flashing .
5. Press **+** or **-** to set the hours and the minutes for END time.
6. Press  to confirm.

Appliance turns on automatically later on, works for the set DURATION time and stops at the set END time. At the set time an acoustic signal sounds for 2

minutes. →| and time setting flash in the display. The appliance deactivates.

7. Press any button to stop the acoustic signal.
8. Turn the knob for the oven functions to the off position.

## 6.6 Setting the MINUTE MINDER



1. Press .  
 and "00" flash in the display.
2. Press  or  to set the MINUTE MINDER.

First you set the seconds, then the minutes.

When the time you set is longer than 60 minutes, **hr** flash in the display.

3. Set the hours.
4. The MINUTE MINDER starts automatically after 5 seconds. After 90% of the set time, an acoustic signal sounds.
5. When the set time ends, an acoustic signal sounds for 2 minutes. "00:00" and  flash in the display. Press any button to stop the acoustic signal.

## 6.7 COUNT UP TIMER

To reset the Count Up Timer, press and hold  and . The timer starts to count up again.

# 7. USING THE ACCESSORIES



**WARNING!**  
Refer to Safety chapters.

## 7.1 Inserting the accessories

Wire shelf:

Push the shelf between the guide bars of the shelf support and make sure that the feet point down.

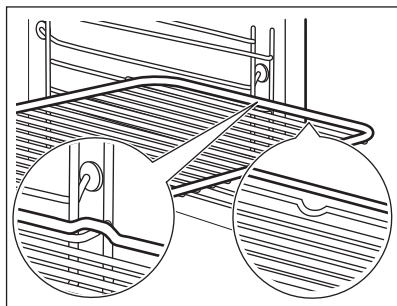

Deep pan:

Push the deep pan between the guide bars of the shelf support.

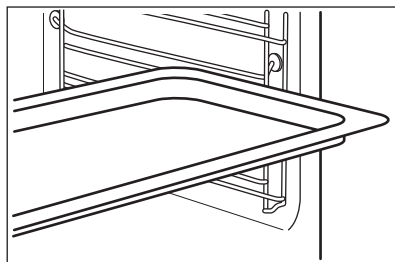

Wire shelf and deep pan together:

Push the deep pan between the guide bars of the shelf support and the wire shelf on the guide bars above.

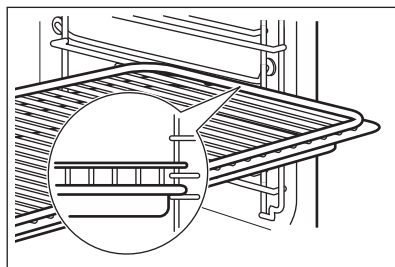



Small indentation at the top increase safety. The indentations are also anti-tip devices. The high rim around the shelf prevents cookware from slipping of the shelf.

## 7.2 Trivet and Grill- / Roasting pan



### WARNING!

Be careful when you remove the accessories from a hot oven. There is a risk of burns.

You can use the trivet to roast larger pieces of meat or poultry on one shelf position.

1. Put the trivet into the deep pan so that the supports of the wire shelf point up.

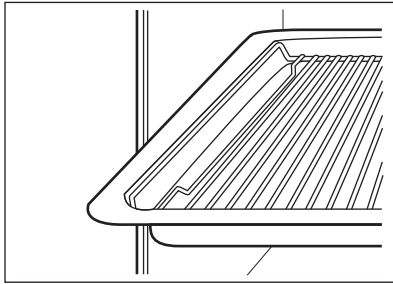

2. Put the deep pan into the oven on the necessary shelf position. You can use the trivet to grill flat dishes in large quantities and to toast.

1. Put the trivet into the deep pan so that the supports of the wire shelf point down.

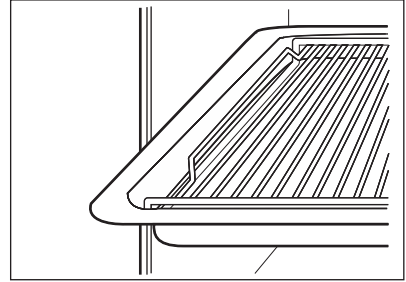



2. Put the deep pan into the oven on the necessary shelf position.

## 8. ADDITIONAL FUNCTIONS

### 8.1 Using the Child Lock

When the Child Lock is on the oven cannot be turned on accidentally.

1. Ensure the knob for the oven functions is in the off position.
2. Press and hold  and  at the same time for 2 seconds.

The signal sounds. SAFE and  appear on the display.





The symbols appear on the display also when Pyrolysis function operates.

To turn off the Child Lock, repeat step 2.

### 8.2 Using the Function Lock

You can turn on the Function Lock function only when the oven operates.

When the Function lock is on the temperature and time settings of a running oven function cannot be changed accidentally.



1. Select an oven function and set it according your preferences.
2. Press and hold  and  at the same time for 2 seconds.

The signal sounds. Loc appears on the display for 5 seconds.

-  Loc appears on the display when you turn the knob for the temperature or press any button when the Function lock is on.

When you turn the knob for the oven functions, the oven stops.

When you turn off the oven while the Function Lock is on, the Function Lock switches automatically to the Child Lock. Refer to "Using the Child Lock".

-  If the Pyrolysis function operates, the door is locked and  appears on the display.

To turn off the Function Lock, repeat step 2.

### 8.3 Residual heat indicator

When you turn off the oven, the display shows the residual heat indicator  if the temperature in the oven is more than 40 °C.

### 8.4 Automatic Switch-off

For safety reasons the appliance deactivates automatically after some

time if an oven function operates and you do not change any settings.

Temperature (°C)	Switch-off time (h)
30 - 115	12.5
120 - 195	8.5
200 - 245	5.5
250 - maximum	1.5

After an automatic switch-off, press any button to operate the appliance again.

-  The Automatic switch-off does not work with the functions: Light, Duration, End.

### 8.5 Cooling fan

When the oven operates, the cooling fan turns on automatically to keep the surfaces of the oven cool. If you turn off the oven, the cooling fan can continue to operate until the oven cools down.

## 9. HINTS AND TIPS

-  **WARNING!**  
Refer to Safety chapters.

-  The temperature and baking times in the tables are guidelines only. They depend on the recipes and the quality and quantity of the ingredients used.

### 9.1 Inner side of the door

**In some models, on the inner side of the door you can find:**

- the numbers of the shelf positions.
- information about the oven functions, recommended shelf positions and temperatures for typical dishes.

### 9.2 True Fan Cooking PLUS

-  Before preheating fill the cavity embossment with water only when the oven is cold.

Refer to "Activating the True Fan Cooking PLUS function"

## Bakery products

Food	Water in the cavity embossment (ml)	Temperature (°C)	Time (min)	Shelf position	Comments
Bread	150	180	35 - 40	2	Use baking tray. <sup>1)</sup>
Bread rolls	150	200	20 - 25	2	Use baking tray. <sup>1)</sup>
Homestyle pizza	150	230	10 - 20	2	Use baking tray. <sup>1)</sup>
Focaccia	150	200 - 210	10 - 20	2	Use baking tray. <sup>1)</sup>
Cookies, scones, croissants	150	150 - 180	10 - 20	2	Use baking tray. <sup>1)</sup>
Plum cake, apple pie, cinnamon rolls	150	160 - 180	30 - 60	2	Use cake mould. <sup>1)</sup>

<sup>1)</sup> Preheat in an empty oven for 5 minutes before cooking.

## Cook from frozen

Food	Water in the cavity embossment (ml)	Temperature (°C)	Time (min)	Shelf position
Pizza frozen	200	200 - 210	10 - 20	2 <sup>1)</sup>
Frozen lasagna	200	180 - 200	35 - 50	2 <sup>1)</sup>
Frozen croissant	200	170 - 180	15 - 25	2 <sup>1)</sup>

<sup>1)</sup> Preheat in an empty oven for 10 minutes before cooking.

## Food regeneration

Food	Water in the cavity embossment (ml)	Temperature (°C)	Time (min)	Shelf position
Bread	100	110	15 - 25	2
Bread rolls	100	110	10 - 20	2
Homestyle pizza	100	110	15 - 25	2
Focaccia	100	110	15 - 25	2
Vegetables	100	110	15 - 25	2



Food	Water in the cavity embossment (ml)	Temperature (°C)	Time (min)	Shelf position
Rice	100	110	15 - 25	2
Pasta	100	110	15 - 25	2
Meat	100	110	15 - 25	2

### Roasting

Food	Water in the cavity embossment (ml)	Temperature (°C)	Time (min)	Shelf position	Comments
Roast pork	200	180	65 - 80	2	Glass baking dish
Roast beef	200	200	50 - 60	2	Glass baking dish
Chicken	200	210	60 - 80	2	Glass baking dish

## 9.3 Baking

- Your oven may bake or roast differently to the oven you had before. Adapt your usual settings such as temperature, cooking time and shelf position to the values in the tables.
- Use the lower temperature the first time.
- If you cannot find the settings for a special recipe, look for the similar one.
- You can extend baking times by 10 – 15 minutes if you bake cakes on more than one shelf position.
- Cakes and pastries at different heights do not always brown equally at first. If this occurs, do not change the temperature setting. The differences equalize during the baking procedure.
- Trays in the oven can twist during baking. When the trays become cold again, the distortions disappear.

## 9.4 Tips on baking

Baking results	Possible cause	Remedy
The bottom of the cake is not browned sufficiently.	The shelf position is incorrect.	Put the cake on a lower shelf.
The cake sinks and becomes soggy, lumpy or streaky.	The oven temperature is too high.	The next time you bake, set a slightly lower oven temperature.
The cake sinks and becomes soggy, lumpy or streaky.	The baking time is too short.	Set a longer baking time. <b>You cannot decrease baking times by setting higher temperatures.</b>

Baking results	Possible cause	Remedy
The cake sinks and becomes soggy, lumpy or streaky.	There is too much liquid in the mixture.	Use less liquid. Be careful with mixing times, especially if you use a mixing machine.
The cake is too dry.	The oven temperature is too low.	The next time you bake, set a higher oven temperature.
The cake is too dry.	The baking time is too long.	The next time you bake, set a shorter baking time.
The cake browns unevenly.	The oven temperature is too high and the baking time is too short.	Set a lower oven temperature and a longer baking time.
The cake browns unevenly.	The mixture is unevenly distributed.	Spread the mixture evenly on the baking tray.
The cake is not ready in the baking time given.	The oven temperature is too low.	The next time you bake, set a slightly higher oven temperature.

## 9.5 Baking on one level:

Baking in tins

Food	Function	Temperature (°C)	Time (min)	Shelf position
Ring cake / Brioche	True Fan Cooking	150 - 160	50 - 70	1
Madeira cake / Fruit cakes	True Fan Cooking	140 - 160	70 - 90	1
Flan base - short pastry	True Fan Cooking	170 - 180 <sup>1)</sup>	10 - 25	2
Flan base - sponge mixture	True Fan Cooking	150 - 170	20 - 25	2
Cheesecake	Top / Bottom Heat	170 - 190	60 - 90	1

<sup>1)</sup> Preheat the oven.

Cakes / pastries / breads on baking trays

Food	Function	Temperature (°C)	Time (min)	Shelf position
Plaited bread / Bread crown	Top / Bottom Heat	170 - 190	30 - 40	3
Christmas stollen	Top / Bottom Heat	160 - 180 <sup>1)</sup>	50 - 70	2

Food	Function	Temperature (°C)	Time (min)	Shelf position
Bread (rye bread): 1. First part of baking procedure. 2. Second part of baking procedure.	Top / Bottom Heat	1. 230 <sup>1)</sup> 2. 160 - 180	1. 20 2. 30 - 60	1
Cream puffs / Eclairs	Top / Bottom Heat	190 - 210 <sup>1)</sup>	20 - 35	3
Swiss roll	Top / Bottom Heat	180 - 200 <sup>1)</sup>	10 - 20	3
Cake with crumble topping (dry)	True Fan Cooking	150 - 160	20 - 40	3
Buttered almond cake / Sugar cakes	Top / Bottom Heat	190 - 210 <sup>1)</sup>	20 - 30	3
Fruit flans (made with yeast dough / sponge mixture) <sup>2)</sup>	True Fan Cooking	150	35 - 55	3
Fruit flans (made with yeast dough / sponge mixture) <sup>2)</sup>	Top / Bottom Heat	170	35 - 55	3
Fruit flans made with short pastry	True Fan Cooking	160 - 170	40 - 80	3
Yeast cakes with delicate toppings (e.g. quark, cream, custard)	Top / Bottom Heat	160 - 180 <sup>1)</sup>	40 - 80	3

<sup>1)</sup> Preheat the oven.

<sup>2)</sup> Use a deep pan.

#### Biscuits

Food	Function	Temperature (°C)	Time (min)	Shelf position
Short pastry biscuits	True Fan Cooking	150 - 160	10 - 20	3
Biscuits made with sponge mixture	True Fan Cooking	150 - 160	15 - 20	3
Pastries made with egg white / Meringues	True Fan Cooking	80 - 100	120 - 150	3
Macaroons	True Fan Cooking	100 - 120	30 - 50	3

Food	Function	Temperature (°C)	Time (min)	Shelf position
Biscuits made with yeast dough	True Fan Cooking	150 - 160	20 - 40	3
Puff pastries	True Fan Cooking	170 - 180 <sup>1)</sup>	20 - 30	3
Rolls	True Fan Cooking	160 <sup>1)</sup>	10 - 25	3
Rolls	Top / Bottom Heat	190 - 210 <sup>1)</sup>	10 - 25	3

<sup>1)</sup> Preheat the oven.

## 9.6 Bakes and gratins

Food	Function	Temperature (°C)	Time (min)	Shelf position
Pasta bake	Top / Bottom Heat	180 - 200	45 - 60	1
Lasagne	Top / Bottom Heat	180 - 200	25 - 40	1
Vegetables au gratin <sup>1)</sup>	Turbo Grilling	160 - 170	15 - 30	1
Baguettes topped with melted cheese	True Fan Cooking	160 - 170	15 - 30	1
Sweet bakes	Top / Bottom Heat	180 - 200	40 - 60	1
Fish bakes	Top / Bottom Heat	180 - 200	30 - 60	1
Stuffed vegetables	True Fan Cooking	160 - 170	30 - 60	1

<sup>1)</sup> Preheat the oven.

## 9.7 Moist Fan Baking



For best results follow the baking times listed in the table below.

Food	Temperature (°C)	Time (min)	Shelf position
Pasta gratin	200 - 220	45 - 55	3
Potato gratin	180 - 200	70 - 85	3
Moussaka	170 - 190	70 - 95	3
Lasagne	180 - 200	75 - 90	3
Cannelloni	180 - 200	70 - 85	3
Bread pudding	190 - 200	55 - 70	3
Rice pudding	170 - 190	45 - 60	3
Apple cake, made with sponge mixture (round cake tin)	160 - 170	70 - 80	3
White bread	190 - 200	55 - 70	3

## 9.8 Multilevel Baking

Use the function True Fan Cooking.

Cakes / pastries / breads on baking trays

Food	Temperature (°C)	Time (min)	Shelf position	
			2 positions	3 positions
Cream puffs / Eclairs	160 - 180 <sup>1)</sup>	25 - 45	1 / 4	-
Dry streusel cake	150 - 160	30 - 45	1 / 4	-

<sup>1)</sup> Preheat the oven.

Biscuits / small cakes / small cakes / pastries / rolls

Food	Temperature (°C)	Time (min)	Shelf position	
			2 positions	3 positions
Short pastry biscuits	150 - 160	20 - 40	1 / 4	1 / 3 / 5
Biscuits made with sponge mixture	160 - 170	25 - 40	1 / 4	-
Biscuits made with egg white, meringues	80 - 100	130 - 170	1 / 4	-
Macaroons	100 - 120	40 - 80	1 / 4	-

Food	Temperature (°C)	Time (min)	Shelf position	
			2 positions	3 positions
Biscuits made with yeast dough	160 - 170	30 - 60	1 / 4	-
Puff pastries	170 - 180 <sup>1)</sup>	30 - 50	1 / 4	-
Rolls	180	20 - 30	1 / 4	-

<sup>1)</sup> Preheat the oven.

## 9.9 True Fan + Bottom

Food	Temperature (°C)	Time (min)	Shelf position
Pizza (thin crust)	200 - 230 <sup>1)2)</sup>	15 - 20	2
Pizza (with a lot of topping)	180 - 200	20 - 30	2
Tarts	180 - 200	40 - 55	1
Spinach flan	160 - 180	45 - 60	1
Quiche Lorraine	170 - 190	45 - 55	1
Swiss Flan	170 - 190	45 - 55	1
Cheesecake	140 - 160	60 - 90	1
Apple cake, covered	150 - 170	50 - 60	1
Vegetable pie	160 - 180	50 - 60	1
Unleavened bread	230 - 250 <sup>1)</sup>	10 - 20	2
Puff pastry flan	160 - 180 <sup>1)</sup>	45 - 55	2
Flammekuchen (Pizza-like dish from Alsace)	230 - 250 <sup>1)</sup>	12 - 20	2
Piroggen (Russian version of calzone)	180 - 200 <sup>1)</sup>	15 - 25	2

<sup>1)</sup> Preheat the oven.

<sup>2)</sup> Use a deep pan.

## 9.10 Roasting

- Use heat-resistant ovenware to roast. Refer to the instructions of the ovenware manufacturer.
- You can roast large roasting joints directly in the deep pan or on the wire shelf above the deep pan.
- Put some liquid in the deep pan to prevent the meat juices or fat from burning on its surface.

- All types of meat that can be browned or have crackling can be roasted in the roasting tin without the lid.
- If necessary, turn the roast after 1/2 to 2/3 of the cooking time.
- To keep meat more succulent:
  - roast lean meat in the roasting tin with the lid or use roasting bag.
  - roast meat and fish in pieces weighting minimum 1 kg.
  - baste large roasts and poultry with their juices several times during roasting.

## 9.11 Roasting tables

### Beef

Food	Quantity	Function	Temperature (°C)	Time (min)	Shelf position
Pot roast	1 - 1.5 kg	Top / Bottom Heat	230	120 - 150	1
Roast beef or fillet: rare	per cm of thickness	Turbo Grilling	190 - 200 <sup>1)</sup>	5 - 6	1
Roast beef or fillet: medium	per cm of thickness	Turbo Grilling	180 - 190 <sup>1)</sup>	6 - 8	1
Roast beef or fillet: well done	per cm of thickness	Turbo Grilling	170 - 180 <sup>1)</sup>	8 - 10	1

<sup>1)</sup> Preheat the oven.

### Pork

Food	Quantity (kg)	Function	Temperature (°C)	Time (min)	Shelf position
Shoulder / Neck / Ham joint	1 - 1.5	Turbo Grilling	160 - 180	90 - 120	1
Chop / Spare rib	1 - 1.5	Turbo Grilling	170 - 180	60 - 90	1
Meatloaf	0.75 - 1	Turbo Grilling	160 - 170	50 - 60	1
Pork knuckle (precooked)	0.75 - 1	Turbo Grilling	150 - 170	90 - 120	1

### Veal

Food	Quantity (kg)	Function	Temperature (°C)	Time (min)	Shelf position
Roast veal	1	Turbo Grilling	160 - 180	90 - 120	1
Knuckle of veal	1.5 - 2	Turbo Grilling	160 - 180	120 - 150	1

## Lamb

Food	Quantity (kg)	Function	Temperature (°C)	Time (min)	Shelf position
Leg of lamb / Roast lamb	1 - 1.5	Turbo Grilling	150 - 170	100 - 120	1
Saddle of lamb	1 - 1.5	Turbo Grilling	160 - 180	40 - 60	1

## Game

Food	Quantity (kg)	Function	Temperature (°C)	Time (min)	Shelf position
Saddle / Leg of hare	up to 1	Top / Bottom Heat	230 <sup>1)</sup>	30 - 40	1
Saddle of venison	1.5 - 2	Top / Bottom Heat	210 - 220	35 - 40	1
Haunch of venison	1.5 - 2	Top / Bottom Heat	180 - 200	60 - 90	1

<sup>1)</sup> Preheat the oven.

## Poultry

Food	Quantity (kg)	Function	Temperature (°C)	Time (min)	Shelf position
Poultry portions	0.2 - 0.25 each	Turbo Grilling	200 - 220	30 - 50	1
Half chicken	0.4 - 0.5 each	Turbo Grilling	190 - 210	35 - 50	1
Chicken, poulard	1 - 1.5	Turbo Grilling	190 - 210	50 - 70	1
Duck	1.5 - 2	Turbo Grilling	180 - 200	80 - 100	1
Goose	3.5 - 5	Turbo Grilling	160 - 180	120 - 180	1
Turkey	2.5 - 3.5	Turbo Grilling	160 - 180	120 - 150	1
Turkey	4 - 6	Turbo Grilling	140 - 160	150 - 240	1

## Fish (steamed)

Food	Quantity (kg)	Function	Temperature (°C)	Time (min)	Shelf position
Whole fish	1 - 1.5	Top / Bottom Heat	210 - 220	40 - 60	1



## 9.12 Grilling

- Always grill with the maximum temperature setting.
- Set the shelf into the shelf position as recommended in the grilling table.
- Always set the pan to collect the fat into the first shelf position.

- Grill only flat pieces of meat or fish.
- Always preheat the empty oven with the grill functions for 5 minutes.



### CAUTION!

Always grill with the oven door closed.

### Grilling

Food	Temperature (°C)	Time (min)		Shelf position
		1st side	2nd side	
Roast beef	210 - 230	30 - 40	30 - 40	2
Filet of beef	230	20 - 30	20 - 30	3
Back of pork	210 - 230	30 - 40	30 - 40	2
Back of veal	210 - 230	30 - 40	30 - 40	2
Back of lamb	210 - 230	25 - 35	20 - 25	3
Whole Fish, 500 - 1000 g	210 - 230	15 - 30	15 - 30	3 / 4

## 9.13 Bottom + Grill + Fan

Use the function True Fan Cooking.

Food	Temperature (°C)	Time (min)	Shelf position
Pizza, frozen	200 - 220	15 - 25	2
Pizza American, frozen	190 - 210	20 - 25	2
Pizza, chilled	210 - 230	13 - 25	2
Pizza Snacks, frozen	180 - 200	15 - 30	2
French Fries, thin	200 - 220	20 - 30	3
French Fries, thick	200 - 220	25 - 35	3
Wedges / Croquettes	220 - 230	20 - 35	3
Hash Browns	210 - 230	20 - 30	3
Lasagne / Cannelloni, fresh	170 - 190	35 - 45	2
Lasagne / Cannelloni, frozen	160 - 180	40 - 60	2
Oven baked cheese	170 - 190	20 - 30	3

Food	Temperature (°C)	Time (min)	Shelf position
Chicken Wings	190 - 210	20 - 30	2

### 9.14 Defrost

- Remove the food packaging and put the food on a plate.
- Use the first shelf position from the bottom.
- Do not cover the food with a bowl or a plate, as this can extend the defrost time.
- For large portions of food place an upturned empty plate on the bottom of the oven cavity. Put the food in a deep plate or dish and set it on top of the plate inside the oven. Remove shelf supports if necessary.

Food	Quantity (kg)	Defrosting time (min)	Further defrosting time (min)	Comments
Chicken	1	100 - 140	20 - 30	Put the chicken on an upturned saucer in a big plate. Turn halfway through.
Meat	1	100 - 140	20 - 30	Turn halfway through.
Meat	0.5	90 - 120	20 - 30	Turn halfway through.
Trout	0.15	25 - 35	10 - 15	-
Strawberries	0.3	30 - 40	10 - 20	-
Butter	0.25	30 - 40	10 - 15	-
Cream	2 x 0.2	80 - 100	10 - 15	Whip the cream when still slightly frozen in places.
Gateau	1.4	60	60	-

### 9.15 Preserving - Bottom Heat

- Use only preserve jars of the same dimensions available on the market.
- Do not use jars with twist-off and bayonet type lids or metal tins.
- Use the first shelf from the bottom for this function.
- Put no more than six one-litre preserve jars on the baking tray.
- Fill the jars equally and close with a clamp.
- The jars cannot touch each other.
- Put approximately 1/2 litre of water into the baking tray to give sufficient moisture in the oven.
- When the liquid in the jars starts to simmer (after approximately 35 - 60 minutes with one-litre jars), stop the oven or decrease the temperature to 100 °C (see the table).

## Soft fruit

Food	Temperature (°C)	Cooking time until simmering (min)	Continue to cook at 100 °C (min)
Strawberries / Blueberries / Raspberries / Ripe gooseberries	160 - 170	35 - 45	-

## Stone fruit

Food	Temperature (°C)	Cooking time until simmering (min)	Continue to cook at 100 °C (min)
Pears / Quinces / Plums	160 - 170	35 - 45	10 - 15

## Vegetables

Food	Temperature (°C)	Cooking time until simmering (min)	Continue to cook at 100 °C (min)
Carrots <sup>1)</sup>	160 - 170	50 - 60	5 - 10
Cucumbers	160 - 170	50 - 60	-
Mixed pickles	160 - 170	50 - 60	5 - 10
Kohlrabi / Peas / Asparagus	160 - 170	50 - 60	15 - 20

<sup>1)</sup> Leave standing in the oven after it is deactivated.

## 9.16 Drying - True Fan Cooking

- Cover trays with grease proof paper or baking parchment.

- For a better result, stop the oven halfway through the drying time, open the door and let it cool down for one night to complete the drying.

## Vegetables

Food	Temperature (°C)	Time (h)	Shelf position	
			1 position	2 positions
Beans	60 - 70	6 - 8	3	1 / 4
Peppers	60 - 70	5 - 6	3	1 / 4
Vegetables for sour	60 - 70	5 - 6	3	1 / 4
Mushrooms	50 - 60	6 - 8	3	1 / 4
Herbs	40 - 50	2 - 3	3	1 / 4

## Fruit

Food	Temperature (°C)	Time (h)	Shelf position	
			1 position	2 positions
Plums	60 - 70	8 - 10	3	1 / 4
Apricots	60 - 70	8 - 10	3	1 / 4
Apple slices	60 - 70	6 - 8	3	1 / 4
Pears	60 - 70	6 - 9	3	1 / 4

## 9.17 Information for test institutes

Tests according to EN 60350-1:2013 and IEC 60350-1:2011.

Baking on one level. Baking in tins

Food	Function	Temperature (°C)	Time (min)	Shelf position
Fatless sponge cake / Fatless sponge cake	True Fan Cooking	140 - 150	35 - 50	2
Fatless sponge cake / Fatless sponge cake	Top / Bottom Heat	160	35 - 50	2
Apple pie / Apple pie (2 tins Ø20 cm, diagonally off set)	True Fan Cooking	160	60 - 90	2
Apple pie / Apple pie (2 tins Ø20 cm, diagonally off set)	Top / Bottom Heat	180	70 - 90	1

Baking on one level. Biscuits

Food	Function	Temperature (°C)	Time (min)	Shelf position
Short bread / Short bread / Pastry stripes	True Fan Cooking	140	25 - 40	3
Short bread / Short bread / Pastry stripes	Top / Bottom Heat	160 <sup>1)</sup>	20 - 30	3
Small cakes / Small cakes (20 per tray)	True Fan Cooking	150 <sup>1)</sup>	20 - 35	3
Small cakes / Small cakes (20 per tray)	Top / Bottom Heat	170 <sup>1)</sup>	20 - 30	3

<sup>1)</sup> Preheat the oven.

Multilevel Baking. Biscuits / small cakes / small cakes / pastries / rolls

Food	Function	Temperature (°C)	Time (min)	Shelf position	
				2 positions	3 positions
Short bread / Short bread / Pastry Stripes	True Fan Cooking.	140	25 - 45	1 / 4	1 / 3 / 5
Small cakes / Small cakes (20 per tray)	True Fan Cooking.	150 <sup>1)</sup>	23 - 40	1 / 4	-

<sup>1)</sup> Preheat the oven.

Grilling

Food	Function	Temperature (°C)	Time (min)	Shelf position
Toast / Toast	Grilling	max	1 - 3 <sup>1)</sup>	5
Beef Steak / Beef Steak	Grilling	max	24 - 30 <sup>1)2)</sup>	4

<sup>1)</sup> Preheat the oven for 5 minutes.

<sup>2)</sup> Turn halfway through.

## 10. CARE AND CLEANING



### WARNING!

Refer to Safety chapters.

### 10.1 Notes on cleaning

- Clean the front of the oven with a soft cloth with warm water and a cleaning agent.
- To clean metal surfaces, use a dedicated cleaning agent.
- Clean the oven interior after each use. Fat accumulation or other food remains may result in a fire. The risk is higher for the grill pan.
- Clean stubborn dirt with a special oven cleaner.
- Clean all accessories after each use and let them dry. Use a soft cloth with warm water and a cleaning agent.
- If you have nonstick accessories, do not clean them using aggressive agents, sharp-edged objects or a dishwasher. It can cause damage to the nonstick coating.

### 10.2 Cleaning the cavity embossment

The cleaning procedure removes limestone residue from the cavity embossment after cooking with steam.



We recommend to do the cleaning procedure at least every 5 - 10 True Fan Cooking PLUS cycles.

1. Put 250 ml of white vinegar into the cavity embossment at the bottom of the oven. Use maximum 6% vinegar without herbs.
2. Let the vinegar dissolve the residual limestone at the ambient temperature for 30 minutes.
3. Clean the cavity with warm water and a soft cloth.

## 10.3 Removing the shelf supports

To clean the oven, remove the shelf supports.



### CAUTION!

Be careful when you remove the shelf supports.

1. Pull the front of the shelf support away from the side wall.

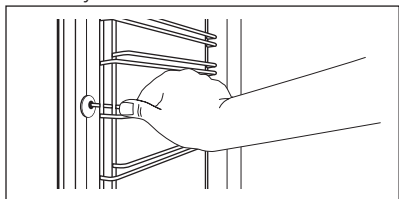

2. Pull the rear end of the shelf support away from the side wall and remove it.

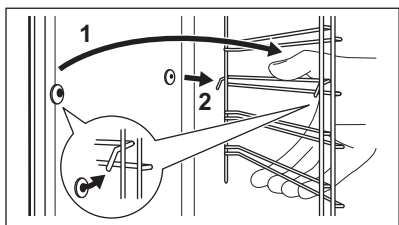

Install the removed accessories in the opposite sequence.

## 10.4 Pyrolysis



### CAUTION!

Do not start the Pyrolysis if the Plus Steam button is pressed in.



### CAUTION!

Remove all accessories and removable shelf supports.



Do not start the Pyrolysis if you did not fully close the oven door. In some models, the display shows "C3" when this error occurs.



### WARNING!

The appliance becomes very hot. There is a risk of burns.



### CAUTION!

If there are other appliances installed in the same cabinet, do not use them when the Pyrolysis function operates. It can cause damage to the appliance.

1. Remove the worst dirt manually.
2. Clean the inner side of the door with hot water, so that the residues do not burn from the hot air.
3. Set the Pyrolysis function. Refer to "Oven functions".
4. When flashes, press **+** or **-** to set the necessary procedure:

Option	Description
P1	If the oven is not very dirty. Time of the procedure: 1 h 30 min.
P2	If you cannot easily remove the dirt. Time of the procedure: 3 h.

After 2 seconds the procedure starts. You can use the End function to delay the start of the cleaning procedure. During the Pyrolysis the oven lamp is off.

5. To change the default length of the procedure (**P1** or **P2**), press to set , and then press **+** or **-** to set the length of the cleaning procedure.
6. When the oven is at its set temperature, the door locks. The display shows the symbol and the bars of the heat indicator until the door unlocks.
7. When Pyrolysis is completed, the display shows the time of day. The oven door stays locked.
8. When the appliance is cool again, an acoustic signal sounds and the door unlocks.

## 10.5 Cleaning reminder

To remind you that the Pyrolysis is necessary, PYR flashes in the display for 10 seconds after each activation and deactivation of the appliance.

### **i** The cleaning reminder goes out:

- after the end of the Pyrolysis function.
- if you press **+** and **-** at the same time while PYR flashes in the display.

## 10.6 Removing and installing the door

You can remove the door and the internal glass panels to clean it. The number of glass panels is different for different models.



### **WARNING!**

Be careful when you remove the door from the appliance. The door is heavy.

1. Open the door fully.
2. Fully lift up the clamping levers (A) on the two door hinges.

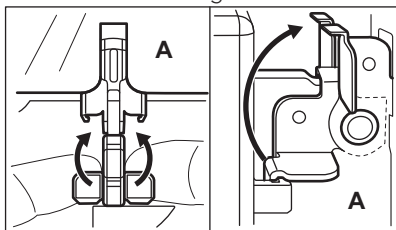

3. Close the door until it is at an angle of approximately 45°.

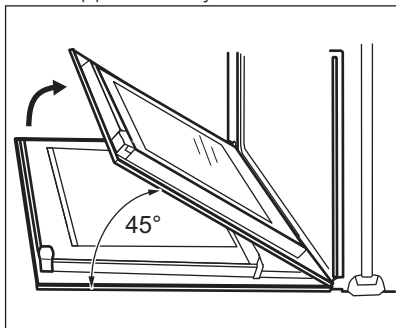

4. Hold the door with one hand on each side and pull it away from the appliance at an upwards angle.
5. Put the door with the outer side down on a soft cloth on a stable surface. This is to prevent scratches.
6. Hold the door trim (B) on the top edge of the door at the two sides and push inwards to release the clip seal.

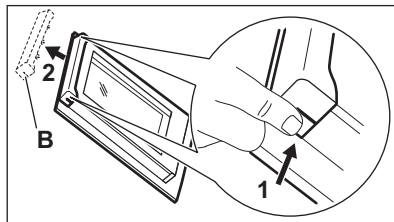

### **CAUTION!**

Rough handling of the glass, especially around the edges of the front panel, can cause the glass to break.

7. Pull the door trim to the front to remove it.
8. Hold the door glass panels on their top edge one by one and pull them up out of the guide.

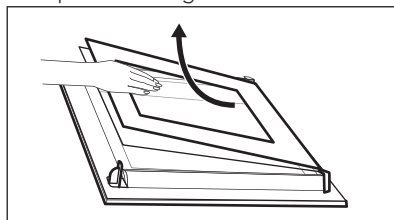

9. Clean the glass panel with water and soap. Dry the glass panel carefully. When the cleaning is completed, do the above steps in the opposite sequence. Install the smaller panel first, then the larger and the door.



### **WARNING!**

Make sure that the glasses are inserted in the correct position otherwise the surface of the door may overheat.

Make sure that you put the glass panels (C, B and A) back in the correct

sequence. First, insert panel C, which has a square printed on the left side and a triangle on the right side. You will also find those symbols embossed on the door frame. The triangle symbol on the glass must match the triangle on the door frame, and the square symbol must match the square. After that insert the other two glass panels.

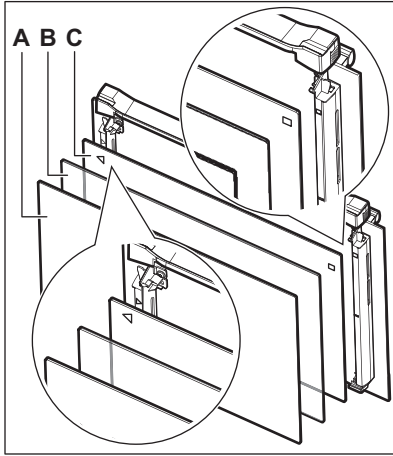

## 10.7 Replacing the lamp

Put a cloth on the bottom of the interior of the appliance. It prevents damage to the lamp glass cover and the cavity.

# 11. TROUBLESHOOTING



**WARNING!**  
Refer to Safety chapters.

## 11.1 What to do if...

Problem	Possible cause	Remedy
You cannot activate or operate the oven.	The oven is not connected to an electrical supply or it is connected incorrectly.	Check if the oven is correctly connected to the electrical supply (refer to the connection diagram if available).
The oven does not heat up.	The oven is deactivated.	Activate the oven.
The oven does not heat up.	The clock is not set.	Set the clock.



### **WARNING!**

Danger of electrocution!  
Disconnect the fuse before you replace the lamp.  
The lamp and the lamp glass cover can be hot.

1. Deactivate the appliance.
2. Remove the fuses from the fuse box or deactivate the circuit breaker.

## The top lamp



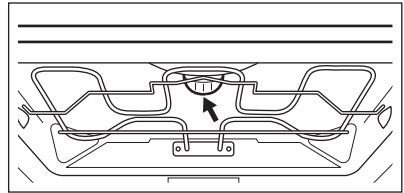

1. Turn the lamp glass cover counterclockwise to remove it.



2. Clean the glass cover.
3. Replace the lamp with a suitable 300 °C heat-resistant lamp.
4. Install the glass cover.



<b>Problem</b>	<b>Possible cause</b>	<b>Remedy</b>
The oven does not heat up.	The necessary settings are not set.	Make sure that the settings are correct.
The oven does not heat up.	The automatic switch-off is activated.	Refer to "Automatic switch-off".
The oven does not heat up.	The Child Lock is on.	Refer to "Using the Child Lock".
The oven does not heat up.	The fuse is blown.	Make sure that the fuse is the cause of the malfunction. If the fuse is blown again and again, contact a qualified electrician.
The lamp does not operate.	The lamp is defective.	Replace the lamp.
It takes too long to cook the dishes or they cook too quickly.	The temperature is too low or too high.	Adjust the temperature if necessary. Follow the advice in the user manual.
Steam and condensation settle on the food and in the cavity of the oven.	You left the dish in the oven for too long.	Do not leave the dishes in the oven for longer than 15 - 20 minutes after the cooking process ends.
The display shows "C3".	The cleaning function does not operate. You did not fully close the door, or the door lock is defective.	Fully close the door.
The display shows "F102".	<ul style="list-style-type: none"> <li>• You did not fully close the door.</li> <li>• The door lock is defective.</li> </ul>	<ul style="list-style-type: none"> <li>• Fully close the door.</li> <li>• Deactivate the oven with the house fuse or the safety switch in the fuse box and activate it again.</li> <li>• If the display shows "F102" again, contact the Customer Care Department.</li> </ul>
The display shows an error code that is not in this table.	There is an electrical fault.	<ul style="list-style-type: none"> <li>• Deactivate the oven with the house fuse or the safety switch in the fuse box and activate it again.</li> <li>• If the display shows the error code again, contact the Customer Care Department.</li> </ul>
There is no good cooking performance using the True Fan Cooking PLUS function.	You did not activate the True Fan Cooking PLUS function.	Refer to "Activating the True Fan Cooking PLUS function".

Problem	Possible cause	Remedy
There is no good cooking performance using the True Fan Cooking PLUS function.	You did not activate correctly the True Fan Cooking PLUS function with the Plus Steam button.	Refer to "Activating the True Fan Cooking PLUS function".
There is no good cooking performance using the True Fan Cooking PLUS function.	You did not fill the cavity embossment with water.	Refer to "Activating the True Fan Cooking PLUS function".
You want to activate the True Fan Cooking function, but the indicator of the Plus Steam button is on.	The True Fan Cooking PLUS function operates.	Push the Plus Steam button  to stop the True Fan Cooking PLUS function.
You want to activate the cleaning function, but the display shows "C4".	The Plus Steam button is pressed in.	Press the Plus Steam button again.
The water in the cavity embossment does not boil.	The temperature is too low.	Set the temperature at least to 110 °C. Refer to "Hints and tips" chapter.
The water comes out of the cavity embossment.	There is too much water in the cavity embossment.	Deactivate the oven and make sure that the appliance is cold. Wipe the water with a cloth or sponge. Add the correct amount of water to the cavity embossment. Refer to the specific procedure.
The appliance is activated and does not heat up. The fan does not operate. The display shows " <b>Demo</b> ".	The demo mode is activated.	<ol style="list-style-type: none"> <li>1. Deactivate the oven.</li> <li>2. Press and hold the button .</li> <li>3. The first digit on the display and <b>Demo</b> indicator start to blink.</li> <li>4. Enter the code 2468 by pressing the buttons  or  to change the values and press  to confirm.</li> <li>5. The next digit starts to blink.</li> <li>6. <b>Demo</b> mode deactivates when you confirm the last digit and the code is correct.</li> </ol>

## 11.2 Service data

If you cannot find a solution to the problem yourself, contact your dealer or an Authorised Service Centre.

The necessary data for the service centre is on the rating plate. The rating plate is

on the front frame of the appliance cavity. Do not remove the rating plate from the appliance cavity.

We recommend that you write the data here:	
Model (MOD.)	.....
Product number (PNC)	.....
Serial number (S.N.)	.....

## 12. ENERGY EFFICIENCY

### 12.1 Product Fiche and information according to EU 65-66/2014

Supplier's name	AEG	
Model identification	BPS551020M BPS551220M	
Energy Efficiency Index	81.2	
Energy efficiency class	A+	
Energy consumption with a standard load, conventional mode	1.09 kWh/cycle	
Energy consumption with a standard load, fan-forced mode	0.69 kWh/cycle	
Number of cavities	1	
Heat source	Electricity	
Volume	71 l	
Type of oven	Built-In Oven	
Mass	BPS551020M	35.5 kg
	BPS551220M	35.5 kg

EN 60350-1 - Household electric cooking appliances - Part 1: Ranges, ovens, steam ovens and grills - Methods for measuring performance.

### 12.2 Energy saving



The oven contains features which help you save energy during everyday cooking.

#### General hints

Make sure that the oven door is closed properly when the appliance operates. Do not open the door too often during

cooking. Keep the door gasket clean and make sure it is well fixed in its position.

Use metal dishes to improve energy saving.

When possible, do not preheat the oven before you put the food inside.

When the cooking duration is longer than 30 minutes, reduce the oven temperature to minimum 3 - 10 minutes before the end of the cooking time, depending on the duration of the cooking. The residual heat inside the oven will continue to cook.

Use the residual heat to warm up other dishes.

Keep breaks between baking as short as possible when you prepare few dishes at one time.

#### **Cooking with fan**

When possible, use the cooking functions with fan to save energy.

#### **Residual heat**

If a programme with the Duration or End Time selection is activated and the cooking time is longer than 30 minutes,

the heating elements automatically deactivate earlier in some oven functions.

The fan and lamp continue to operate.

#### **Keep food warm**

Choose the lowest possible temperature setting to use residual heat and keep a meal warm. The residual heat indicator or temperature appears on the display.

#### **Cooking with the lamp off**

Turn off the lamp during cooking. Turn it on only when you need it.

#### **Moist Fan Baking**

Function designed to save energy during cooking. It operates in such a way that the temperature in the oven cavity may differ from the temperature indicated on the display during a cooking cycle and cooking times may be different from the cooking times in other programmes.

When you use Moist Fan Baking, the lamp automatically turns off after 30 seconds. You may turn on the lamp again but this action will reduce the expected energy savings.

## 13. ENVIRONMENTAL CONCERNS

Recycle materials with the symbol . Put the packaging in relevant containers to recycle it. Help protect the environment and human health by recycling waste of electrical and electronic appliances. Do not dispose of

appliances marked with the symbol  with the household waste. Return the product to your local recycling facility or contact your municipal office.







[www.aeg.com/shop](http://www.aeg.com/shop)



867336307-C-292017



**AEG**