

GB

English

TCM570

### Contents

#### Important information, 2-3

#### Installation, 4

- Where to put your dryer
- Ventilation
- Door reversal instructions
- Water drain
- Electrical connection
- Before you start using your dryer

#### Dryer description, 5

- To open the door
- The features
- Control panel

#### Start and programmes, 6

- Choosing a programme

#### Laundry, 7-8

- Sorting your laundry
- Wash care labels
- Special clothing items
- Drying times

#### Warnings and Suggestions, 9

- General safety
- Disposal
- Saving energy and respecting the environment

#### Maintenance and Care, 10

- Switching off the electricity
- Cleaning the filter after each cycle
- Check the drum after each cycle
- Empty the water container after each cycle
- Cleaning the condenser unit
- Cleaning the dryer

#### Troubleshooting, 11

#### Service, 12

#### Hotpoint Guarantee, 15

#### Hotpoint After Sales Service, 16

! Keep this instruction booklet on hand in order to refer to it when necessary. Take it with you when you move, and should you sell this appliance or pass it on to another party, make sure that this booklet is supplied along with the dryer so that the new owner may be informed about warnings and suggestions on how the appliance works.

! Read these instructions carefully; the following pages contain important information on installation and suggestions on how the appliance works.

 **Hotpoint**

GB

Important  
Information

Installation

Description

Start and  
Programmes

Laundry

Warnings and  
Suggestions

Maintenance  
and Care

Troubleshooting

Service

# Important Information

GB

For your Condenser dryer to operate efficiently, you must follow the regular maintenance schedule shown below:

## Fluff filter...

! You MUST clean the fluff filter after EVERY drying cycle.

### STEP 1.

Open the door of your dryer.



### STEP 2.

Pull out the filter (using the two finger grips).

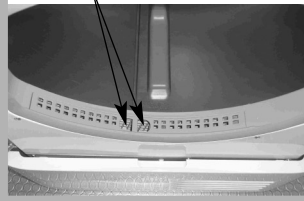

### STEP 3.

Clean any fluff deposits from the filter mesh.

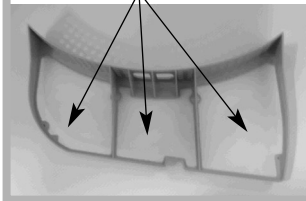

### STEP 4.

Refit the filter - NEVER run the dryer without the filter in position.



! Failure to clean the filter after EVERY drying cycle will affect the drying performance of your machine.

- It will take longer to dry and as a result will use more electricity during drying.

## Water Container...

! You MUST empty the water container after EVERY drying cycle.

### STEP 1.

Pull the water container towards you and remove it fully from the dryer.



### STEP 2.

Empty all the water collected in the water container.

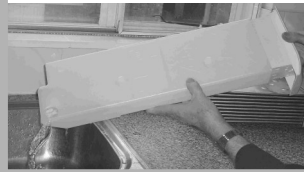

### STEP 3.

Refit the water container, ensuring that it is pushed fully back into position.



! Failure to empty the water container will result in:

- The machine will stop heating (so the load may still be wet at the end of the drying cycle).
- The 'Empty Water' light will illuminate to tell you that the water container is full.

## Priming the Water Collection System

When your dryer is new, the water container will not collect water until the system is primed... this will take 1 or 2 drying cycles. Once primed it will collect water during every drying cycle.

# Important Information



## Condenser Unit...

! You MUST clean the fluff from the condenser EVERY month.

### STEP 1.

Open the condenser cover - hold the handle and pull towards you.

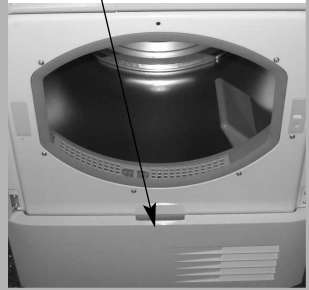

### STEP 2.

Remove the condenser by rotating the 3 clips then pulling the condenser towards you. (There may be some water in the tubes, this is normal).

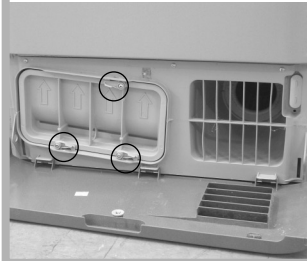

### STEP 3.

Flush the condenser, from the rear with water, to remove any fluff deposits.



### STEP 4.

Refit the condenser unit - ensure that the unit is pushed in fully, all 3 clips are re-secured and the positioning arrows on the front of the condenser are pointing upwards.

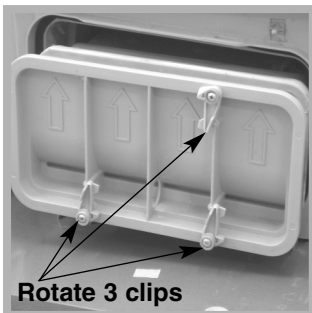
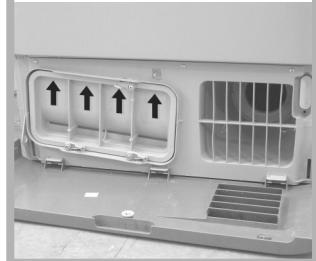

- Check that:
  - The positioning arrows are pointing upwards.
  - The 3 clips are re-secured back into their 'lock' position.

! Failure to clean the condenser could cause premature failure of your dryer.

GB

Important Information

Installation

Description

Start and Programmes

Laundry

Warnings and Suggestions

Maintenance and Care

Troubleshooting

Service

# Installation

GB

## Where to put your dryer

- Place your dryer at a distance from gas ranges, stoves, heaters, or cook tops because flames can damage the appliance.

Minimum gap 10mm

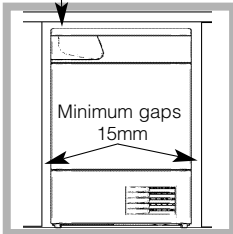

- If you are going to install the appliance under a work counter, be sure to leave a 10mm space between the top and any other objects on or above the machine and a 15mm space between the sides and lateral furnishings or walls. This is to ensure

proper air circulation. Make sure that the back vents are not obstructed.

## Ventilation

When the dryer is in use, there has to be adequate ventilation. Make sure you put your dryer in an environment that is not damp and has proper air circulation throughout. Airflow around the dryer is essential to condense the water produced during the washing, the dryer will not operate efficiently in an enclosed space or cupboard.

! We do not recommend that the dryer is installed in a cupboard but the dryer must never be installed behind a lockable door, a sliding door or a door with a hinge on the opposite side to that of the dryer door.

! If using the dryer in a small or cold room some condensation could be experienced.

## Door Reversal Instructions

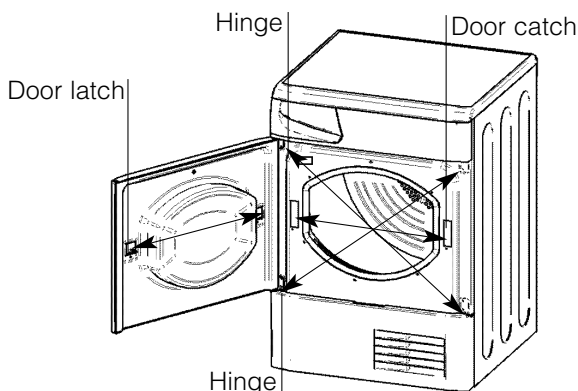

The door of your dryer is reversible and can easily be changed. Exchange diagonally hinge brackets and blanking screws. Exchange door latch and catch with their opposite blanking plates (*see diagram above*).

## Water drain

If your dryer is installed next to a drain the water can be plumbed into this drain. This does away with the need to empty the water container. If the dryer is stacked onto or installed next to a washing machine it can share the same drain. The height of the drain must be less than 3' (1m) from the bottom of the dryer.



Remove the existing clip and hose from position shown (*see diagram*).

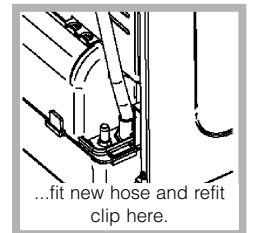

Fit a suitable length of hose to the new location shown (*see diagram*) and refit clip.

! Make sure that the hose is not squashed or kinked when the dryer is in its final location.

## Electrical connections

Make sure of the following before you insert the plug into the the electrical socket:

- The socket must be grounded.
- The socket must be able to sustain the machines maximum power, which is indicated on the rating label (*see Dryer Description*).
- Power voltage must be within the values indicated on the rating label (*see Dryer Description*).
- The socket must be compatible with the dryers plug. Should this not be the case, replace the plug or the socket.

! The dryer must not be installed outdoors, even if the space is sheltered. It can be very dangerous if it is exposed to rain or storms.

! Once installed, the dryers electrical wire and plug must be within easy reach.

! Do not use extension cords.

! The power cord must not be bent or squashed.

! The power cord supplied should be checked periodically and replaced by a cord specially prepared for this dryer and fitted only by authorised technicians (*see Service*). New or longer power cords are supplied at an extra charge by authorised dealers.

! The manufacturer denies any responsibility should any of these rules not be followed.

! If in doubt about any of the above consult a qualified electrician.

## Before you start using your dryer

Once you have installed your dryer and before you use it, clean the inside of the drum to remove any dust that could have accumulated during transport.

# Dryer Description



## To open the door

Press and release the front panel in position shown

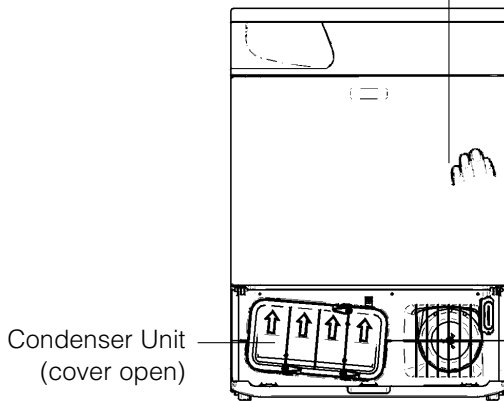

## The features

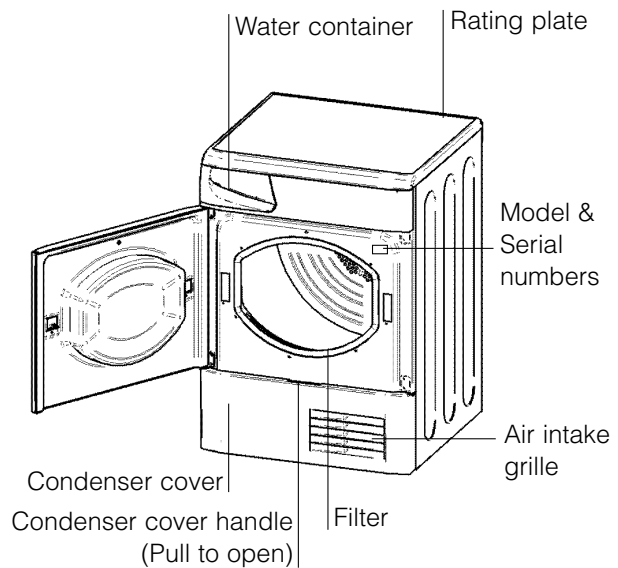

## Control panel

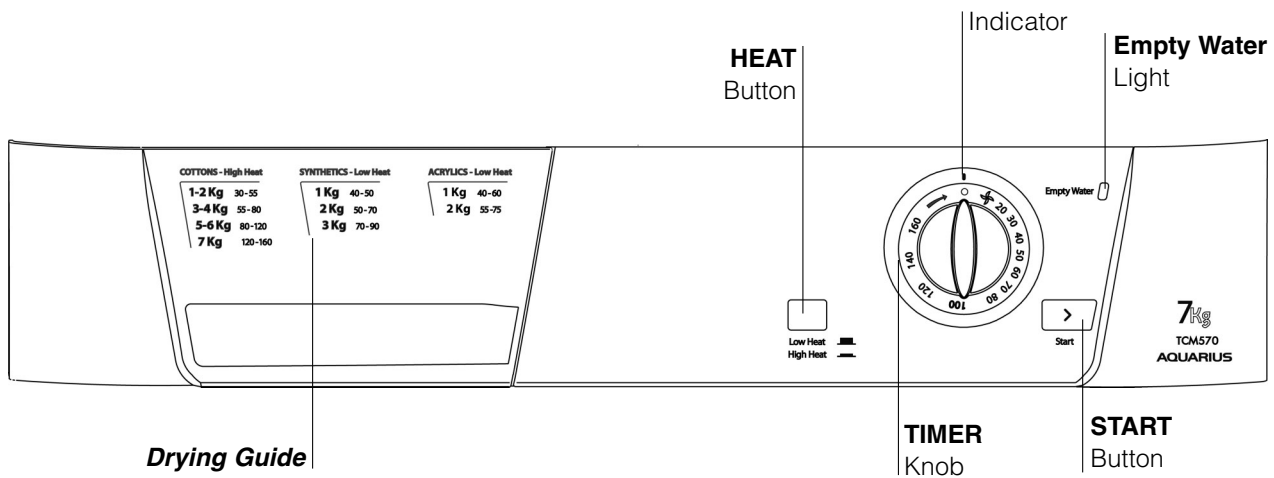

The **START** button > begins drying a selected programme (see *Start and Programmes*).

The **HEAT** button selects drying temperature (see *Start and Programmes*).

OUT: Low heat

IN: High heat

The **Drying Guide** allows you to consult a user friendly table of fabric types and load capacities.

- Cottons
- Synthetics
- Acrylics and other delicates

The **Empty Water** indicator light signals that the water container is full and must be emptied. The light will take a few seconds to go out after replacing the empty water container, the dryer must be running for this to happen.

**Note:** If the water container fills, the light illuminates, the heat is turned off and your laundry will not dry.

The **TIMER** knob sets a drying time. Rotate it clockwise, **never counter-clockwise**, until the indicator is pointing to the drying time you want to select (see *Start and Programmes*).

GB

Important Information

Installation

Description

Start and Programmes

Laundry

Warnings and Suggestions

Maintenance and Care

Troubleshooting

Service

# Start and Programmes

GB

## Choosing a programme

1. Plug the dryer into the electrical socket.
2. Sort your laundry according to fabric type (*see Laundry*).
3. Open the door make sure the filter is clean and in place and the water container is empty and in place (*see Maintenance*).
4. Load the machine and make sure items are not in the way of the door seal. Close the door.
5. Choose the drying time by checking the Drying Guide table for the type of fabric you are drying (*see Laundry*).
  - Set the temperature with the HEAT button.
  - Select a drying time by rotating the TIMER knob clockwise\*.
6. Press the START button to begin.  
During the drying programme, you can check on your laundry and take out items that are dry while others continue drying. When you close the door again, press the START button in order to resume drying.
7. About 10 minutes before the programme is completed, it enters the final COOL TUMBLE phase (fabrics are cooled), which should always be allowed to complete.
8. Open the door, take the laundry out, clean the filter and replace it. Empty the water container and replace it (*see Maintenance*).
9. Unplug the dryer.

**Note:** The COOL TUMBLE programme can be used to refresh fibres of clothing.  
- Set the TIMER with the cool tumble symbol inline with the indicator at Step 5 above\* if you need this feature.

## Sorting your laundry

- Check symbols on clothing labels to make sure that the articles can be tumble dried.
- Sort laundry by fabric type.
- Empty pockets and check buttons.
- Close zippers and hooks and tie loose belts and strings.
- Wring out each item in order to eliminate as much excess water as possible.

! Do not load dripping wet clothes into the dryer.

### Maximum load size

Do not load more than maximum capacity.

These numbers refer to dry weight:

Natural fibres: 7kg max (15lb)

Synthetic fibres: 3kg max (6.6lb)

! DO NOT overload the dryer as this could result in reduced drying performance.

## Typical weights

**Note:** 1kg = 1000g (1lb = 16oz)

Clothes			
Blouse	Cotton	150g	(5oz)
	Other	100g	(3oz)
Dress	Cotton	500g	(1lb 2oz)
	Other	350g	(12oz)
Jeans		700g	(1lb 6oz)
10 nappies		1000g	(2lb 3oz)
Shirt	Cotton	300g	(10oz)
	Other	200g	(7oz)
T-Shirt		125g	(4oz)

Household Items			
Duvet cover (Double)	Cotton	1500g	(3lb 5oz)
	Other	1000g	(2lb 3oz)
Large Tablecloth		700g	(1lb 6oz)
Small Tablecloth		250g	(9oz)
Tea Towel		100g	(3oz)
Bath Towel		700g	(1lb 6oz)
Hand Towel		350g	(12oz)
Double Sheet		500g	(1lb 2oz)
Single Sheet		350g	(12oz)

At the end of a drying cycle, cottons could still be damp if you grouped cottons and synthetics together. If this happens simply give them an additional short period of drying.

- **Note:** The last 10 minutes of any time set is the Cool Tumble, so allow for this when setting the time, as this period will not dry your laundry.

## Wash Care Labels

Look at the labels on your garments, especially when tumble drying for the first time. The following symbols are the most common:

- May be tumble dried
- Do **not** tumble dry
- Tumble dry at high heat setting
- Tumble dry at low heat setting

## Items not suitable for tumble drying

- Articles that containing rubber or rubber-like materials or plastic film (pillows, cushions, or PVC rainwear), any other flammable articles or objects that contain flammable substances (towels soiled with hair spray).
- Glass fibres (certain types of draperies)
- Items which have been dry cleaned
- Items with the ITCL Code (*see Special clothing items*). These can be cleaned with special at-home dry cleaning products. Follow instructions carefully.
- Large bulky items (quilts, sleeping bags, pillows, cushions, large bedspreads etc). These expand when drying and would prevent airflow through the dryer.

GB

Important Information

Installation

Description

Start and Programmes

Laundry

Warnings and Suggestions

Maintenance and Care

Troubleshooting

Service

# Laundry

GB

## Special clothing items







**Blankets and Bedspreads:** acrylic items (Acilan, Courtelle, Orion, Dralon) **must be dried** with special care on LOW heat setting. Avoid drying for a long period of time.

**Pleated or creased garments:** read the manufacturer's drying instructions on the garment.

**Starched articles:** do not dry these with non-starched items. Make sure that as much of the starch solution is removed from the load as possible before placing it in the dryer. Do not over-dry: the starch will become powdery and leave your clothing limp, which defeats the purpose of starch.

## Drying times

The table below presents APPROXIMATE drying times in minutes. Weights refer to dry garments:

Cottons  						
High (full) Heat 						
Drying times 800-1000rpm in washing machine						
		Half Load				Full Load
1kg	2kg	3kg	4kg	5kg	6kg	7kg
30-40	40-55	55-70	70-80	80-90	95-120	120-140
Synthetics 						
Low (gentle) Heat 						
Drying times on reduced spin in washing machine						
		Half Load		Full Load		
1kg		2kg		3kg		
40-50		50-70		70-90		
Acrylics 						
Low (gentle) Heat 						
Drying times on reduced spin in washing machine						
Half Load			Full Load			
1kg			2kg			
40-60			55-75			

Times are approximate and can vary depending upon:

- Amount of water retained in clothes after spin cycle: towels and delicates retain a lot of water.
- Fabrics: items that are the same type of fabric but different textures and thicknesses may not have the same drying time.
- Quantity of laundry: single items or small loads may take longer to dry.
- Dryness: If you are going to iron some of your clothes, they can be taken out while still a bit damp. Others can be left longer if you need them to be completely dry.
- Heat setting.
- Room temperature: if the room where the dryer is located is cold, it will take longer for the dryer to dry your clothes.
- Bulk: some bulky items can be tumble dried with care. We suggest that you remove these items several times, shake them out, and return them to the dryer until finished.

! Do not over-dry your clothes.

All fabrics contain a little natural moisture, which keeps them soft and fluffy.



# Warnings and Suggestions

! The appliance has been designed and built according to international safety standards. These warnings are given for safety reasons and must be followed carefully.

## General safety

- This tumble dryer is not intended for use by persons (including children) with reduced physical, sensory or mental capabilities, or lack of experience and knowledge, unless they have been given supervision or instruction concerning use of the appliance by a person responsible for their safety.
- This tumble dryer has been designed for home, and not professional use.
- Do not touch the appliance while barefoot or with wet hands or feet.
- Unplug the machine by pulling on the plug, not the cord.
- Children must not be in proximity of the dryer when in use. After using the dryer, turn it off and unplug it. Keep the door closed to make sure that children do not use it as a toy.
- Children should be supervised to ensure that they do not play with the dryer.
- The appliance must be installed correctly and have proper ventilation. The air intake at the front of the dryer and rear vent behind the dryer should never be obstructed (*see Installation*).
- Never use the dryer on carpeting where the pile height would prevent air from entering the dryer from the base.
- Check to see if the dryer is empty before loading it.
-  The back of the dryer could become very hot. Never touch it while in use.
- Do not use the dryer unless the filter, water container and condenser are securely in place (*see Maintenance*).
- Do not use liquid fabric softeners in the dryer, add it to the final rinse of your wash.
- Do not overload the dryer (*see Laundry* for maximum loads).
- Do not load items that are dripping wet.
- Tumble dry items only if they have been washed with detergent and water, rinsed and been through the spin cycle. It is a fire hazard to dry items that HAVE NOT been washed with water.
- Carefully check all instructions on clothing labels (*see Laundry*).
- Do not dry garments that have been treated with chemical products.
- Never dry articles that are contaminated with flammable substances (cooking oil, acetone, alcohol, petrol, kerosene, spot removers, turpentine, waxes, wax removers and hair sprays), unless washed in hot water with an extra amount of detergent.
- Do not tumble dry rubber, rubber backed articles and clothes, pillows fitted with foam rubber pads, foam (latex foam), rubber, plastic, shower caps, waterproof textiles, nappy pants or liners, polythene or paper.

- Do not tumble dry large, very bulky items.
- Do not tumble dry acrylic fibres at high temperatures.
- Remove all objects from pockets, especially lighters (risk of explosion).
- Complete each programme with its Cool Tumble Phase.
- Do not turn off the dryer when there are still warm items inside.
- Clean the filter after each use (*see Maintenance*).
- Empty the water container after each use (*see Maintenance*).
- Clean the condenser unit at regular intervals (*see Maintenance*).
- Do not allow lint to collect around the dryer.
- Never climb on top of the dryer. It could result in damage.
- Always follow electrical standards and requirements (*see Installation*).
- Always buy original spare parts and accessories (*see Service*).

! **WARNING:** Never stop the dryer before the end of the drying cycle unless all items are quickly removed and spread out so that the heat is dissipated.

## Recycling and disposal information



As part of our continued commitment to helping the environment, we reserve the right to use quality recycled components to keep down customer costs and minimise material wastage.

- Disposing of the packaging material: follow local regulations, so the packaging can be recycled.
- To minimise risk of injury to children, remove the door and plug - then cut off mains cable, flush with the appliance. Dispose of these parts separately to ensure that the appliance can no longer be plugged into a mains socket.

## Disposal of old electrical appliances

The European Directive 2002/96/EC on Waste Electrical and Electronic Equipment (WEEE), requires that old household electrical appliances must not be disposed of in the normal unsorted municipal waste stream. Old appliances must be collected separately in order to optimise the recovery and recycling of the materials they contain and reduce the impact on human health and the environment.



The crossed out "wheeled bin" symbol on the product reminds you of your obligation, that when you dispose of the appliance it must be separately collected.

Consumers should contact their local authority or retailer for information concerning the correct disposal of their old appliance.

## Saving energy and respecting the environment

- Wring out items to eliminate excess water before tumble drying (if you use a washing machine first, select a high spin cycle). Doing this will save time and energy during drying.
- Always dry full loads - you save energy: single items or small loads take longer to dry.
- Clean the filter after each use to contain energy consumption costs (*see Maintenance*).

GB

Important Information

Installation

Description

Start and Programmes

Laundry

Warnings and Suggestions

Maintenance and Care

Troubleshooting

Service

# Maintenance and Care

GB

## Switching off the electricity

! Unplug your dryer when not using it, when cleaning it and during all maintenance operations.

## Clean the filter after each cycle

The filter is an important part of your dryer: it accumulates lint and fluff that is formed while drying. When finished drying, clean the filter by rinsing it under running water or with your vacuum cleaner. Should the filter become clogged up, the airflow inside the dryer will be seriously compromised: drying times lengthen and you will consume more energy. It may also damage your dryer.

The filter is found in front of the dryer trim (*see diagram*). Removing the filter:

1. Pull the plastic grip of the filter upwards (*see diagram*).
2. Clean the filter and replace it correctly.  
Ensure the filter is fully located flush into the tumble dryer trim.

! Do not use the dryer without replacing the filter.

## Empty the water container after each cycle

Pull the container out of the dryer and empty it into a sink or other suitable drain.

Replace the water container securely.

Always check and empty the container before you start a new drying programme.

## Check the drum after each cycle

Turn the drum manually in order to remove small items (handkerchiefs) that could have been left behind.

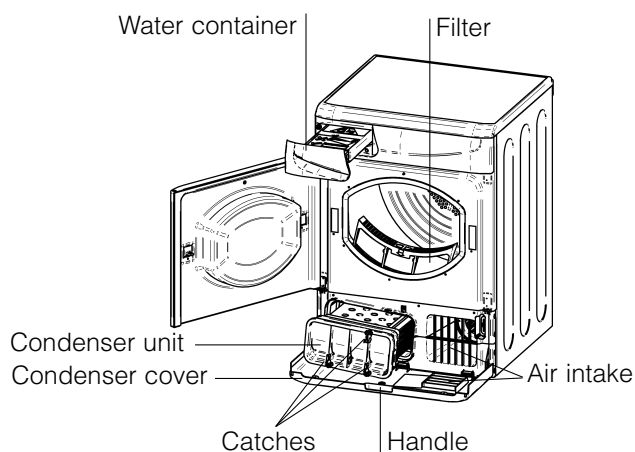

## Cleaning the drum

! Do not use abrasives, steel wool or stainless steel cleaning agents to clean the drum.

A coloured film may start to appear on the stainless steel drum, this may be caused by a combination of water and, or cleaning agents such as fabric conditioner from the wash. This coloured film will not affect the dryer performance.

## Cleaning the condenser unit

Periodically (every month) remove the condenser unit and clean any build up of fluff from between the plates by rinsing it under the tap with cold water.

This should be done with cold water from the rear of the condenser.

Removing the condenser:

1. Unplug the dryer and open the door.
2. Pull open the condenser cover (*see diagram*).  
Release the three catches by turning 90° counter-clockwise then pull on the grip and remove from the dryer.
3. Clean the surface of the seals and replace, making sure that the catches have been secured.

## Cleaning the dryer

- External parts in metal or plastic and rubber parts can be cleaned with a damp cloth.
- Periodically (every 6 months) vacuum the front air intake grille and vents at the rear of the dryer, to remove any build up of fluff, lint or dust. Also to remove accumulation of fluff from the front of the condenser and filter areas, clean occasionally with a vacuum cleaner.

! Do not use solvents or abrasives.

! Your dryer uses special bearing components which do not need lubrication.

! Have your dryer checked regularly by authorised technicians to ensure electrical and mechanical safety (*see Service*).

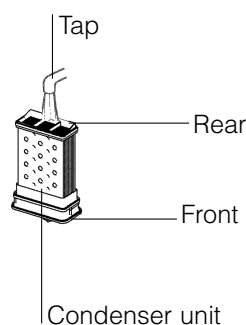

One day your dryer seems not to be working. Before you call your Service Centre (*see Service*), go through the following troubleshooting suggestions:

**Problem:**

**Possible causes / Solution:**

**The tumble dryer won't start.**

- The plug is not plugged into the socket, or not making contact.
- There has been a power failure.
- The fuse has blown. Try to plug another appliance into the socket.
- You are using an extension cord? Try to plug the dryer's power cord directly into the socket.
- The door is not closed securely?
- The TIMER knob has not been set properly (*see Start and Programmes*).
- The START button has not been pressed (*see Start and Programmes*).

**Its taking a long time to dry.**

- The filter has not been cleaned (*see Maintenance*).
- The water container needs emptying? The empty water light is on? (*see Maintenance*).
- The condenser needs cleaning? (*see Maintenance*).
- The temperature setting is not ideal for the type of fabric you are drying (*see Start and Programmes, and see Laundry*).
- The correct drying time has not been selected for the load (*see Laundry*).
- The air intake grille or rear vents are obstructed (*see Installation, and see Maintenance*).
- The items were too wet (*see Laundry*).
- The dryer was overloaded (*see Laundry*).

GB
Important Information
Installation
Description
Start and Programmes
Laundry
Warnings and Suggestions
Maintenance and Care
Troubleshooting
Service

## Before calling the Service Centre:

- Use the troubleshooting guide to see if you can solve the problem yourself (*see Troubleshooting*).
- If not, turn off the dryer and call the Service Centre closest to you.

## What to tell the Service Centre:

- name, address and post code.
- telephone number.
- the type of problem.
- the date of purchase.
- the appliance model (Mod.).
- the serial number (S/N).

This information can be found on the data label inside the door of the machine.

## Spare Parts

This dryer is a complex machine. Repairing it yourself or having a non-authorised person try to repair it could cause harm to one or more persons, could damage the machine and could invalidate the spare parts warranty.

Call an authorised technician if you experience problems while using the machine.

The spare parts have been designed exclusively for this appliance and not for other uses.



This appliance conforms to the following EC Directives:  
- 2006/95/EC (Low Voltage Equipment)  
- 89/336/EEC, 92/31/EEC and 93/68/EEC (Electromagnetic Compatibility)







## Guarantee

### 12 months Parts and Labour Guarantee

Your appliance has the benefit of our manufacturer's guarantee, which covers the cost of breakdown repairs for twelve months from the date of purchase.

This gives you the reassurance that if, within that time, your appliance is proven to be defective because of either workmanship or materials, we will, at our discretion, either repair or replace the appliance at no cost to you.

#### The guarantee is subject to the following conditions:

- The appliance has been installed and operated correctly and in accordance with our operating and maintenance instructions.
- The appliance is only used on the electricity or gas supply printed on the rating plate.
- The appliance has been used for normal domestic purposes only.
- The appliance has not been altered, serviced, maintained, dismantled or otherwise interfered with by any person not authorised by us.
- Any repair work must be undertaken by us or our appointed agent.
- Any parts removed during repair work or any appliance that is replaced become our property.
- The appliance is used in the United Kingdom or Republic of Ireland.

#### The guarantee does not cover:

- Damage resulting from transportation, improper use, neglect or interference or as a result of improper installation.
- Replacement of any consumable item or accessory. These include but are not limited to: plugs, cables, batteries, light bulbs, fluorescent tubes and starters, covers and filters.
- Replacement of any removable parts made of glass or plastic.

THE GUARANTEE WILL NOT APPLY IF THE APPLIANCE HAS BEEN USED IN COMMERCIAL OR NON-DOMESTIC PREMISES.

### 5 Year Parts Guarantee

Hotpoint also offers you a FREE 5 year parts guarantee. This additional guarantee is conditional on you registering your appliance with us and the parts being fitted by one of our authorised engineers. There will be a charge for our engineer's time.

To activate the extra parts warranty on your appliance, simply call our registered line on **08448 24 24 24 (Republic of Ireland 01 230 0800)**

### Extended Guarantees

We offer a selection of protection plans that enable you to fully cover yourself against the expense of repair bills for the life of your policy. To find the ideal plan for you please call our advice line on **08448 226 226 (Republic of Ireland 01 230 0233)**

### Free Helpdesk Service

We have a dedicated team who can provide free advice and assistance with your appliance if you experience any technical difficulties within the first 90 days of ownership. Simply call our Hotpoint Service Hotline on **08448 224 224 (Republic of Ireland 0818 313 413)** for telephone assistance, or, where necessary, to arrange for an engineer to call.



195067258.01 W

03/2009 - SIMLEX . Four Ashes, Wolverhampton



## After Sales Service

No one is better placed to care for your Hotpoint appliance during the course of its working life than us - the manufacturer.

### Essential Contact Information

#### Hotpoint Service

We are the largest service team in the country offering you access to 400 skilled telephone advisors and 1100 fully qualified engineers on call to ensure you receive fast, reliable, local service.

**UK: 08448 224 224**

**Republic of Ireland: 0818 313 413**

**[www.hotpointservice.co.uk](http://www.hotpointservice.co.uk)**

**Please note: Our advisors will require the following information:**

Model number

Serial number

#### Parts and Accessories

We supply a full range of genuine replacement parts as well as accessory products that protect and hygienically clean your appliance to keep it looking good and functioning efficiently throughout its life.

**UK: 08448 225 225**

**Republic of Ireland: 0818 313 413**

**[www.hotpointservice.co.uk](http://www.hotpointservice.co.uk)**

#### Appliance Registration

We want to give you additional benefits of Hotpoint ownership. To activate your FREE 5 year parts guarantee you must register your appliance with us.

**UK: 08448 24 24 24**

**Republic of Ireland: 01 230 0800**

**[www.hotpointservice.co.uk](http://www.hotpointservice.co.uk)**

#### Recycling and Disposal Information

As part of Hotpoint's continued commitment to helping the environment, Hotpoint reserves the right to use quality, recycled components to keep down customer costs and minimise material wastage.

Please dispose of packaging and old appliances carefully. To minimise the risk of injury to children, remove the door, plug, and cut the mains cable off flush with the appliance. Dispose of these parts separately to ensure that the appliance can no longer be plugged into a mains socket and the door cannot be locked shut.