

**Hisense**

# USER MANUAL

Read the manual carefully and ensure you have fully understood its contents before operating this device for the first time.

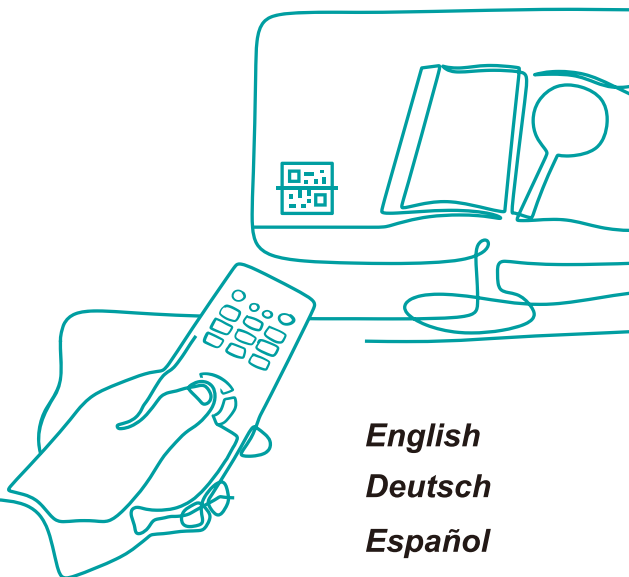

***English***  
***Deutsch***  
***Español***  
***Italiano***  
***Português***  
***Français***  
***Nederlands***

**Hisense**

# USER MANUAL

Read the manual carefully and ensure you have fully understood its contents before operating this device for the first time.

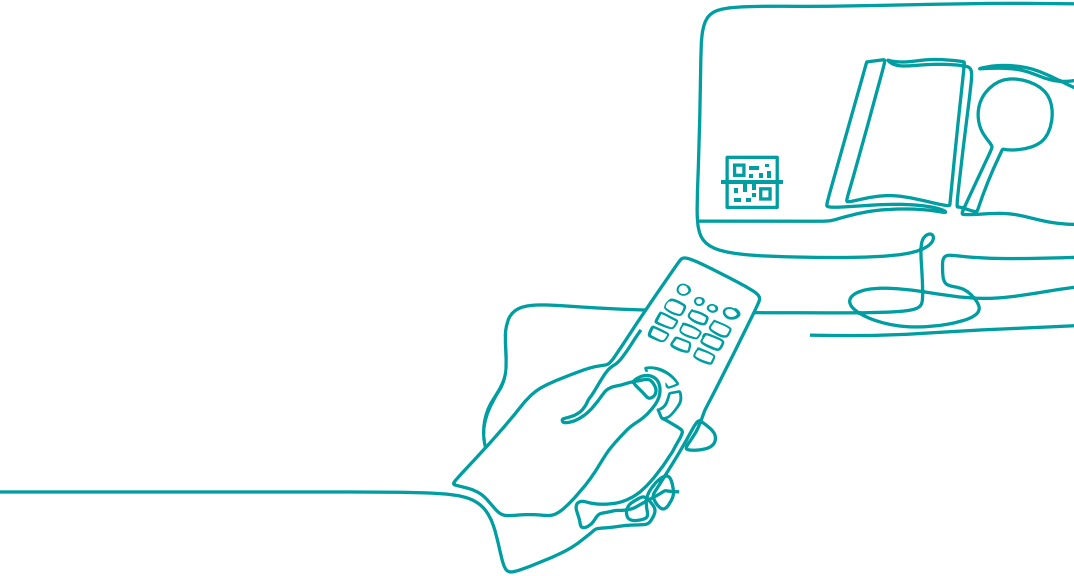

**English**

# Find what you want

This TV is equipped with a user manual and embedded E-Manual.  
Before using the TV, please read the following documentation.

## User Manual

Please read the user manual to learn about the following content:

Accessories  
Installation  
Specifications



## E-Manual

To get more information, please check the E-Manual.

Find the E-Manual in **Settings > Support > E-Manual**.



## E-Manual support functions



**Search**

Find the help you are looking for.

---



**Try Now**

Go directly to the function page and try it.

---



**QR Code**

Scan to open the E-Manual on your mobile device.

## Important Safety Instructions

### Important Notice

Paragraphs beginning with the symbol  indicate important instructions, tips or conditions for the following settings.

 **For your own safety and the optimal performance of your TV, ensure to read the safety instructions before performing any installation.**

Compatibility with 3rd party products, software and services are not guaranteed. We cannot be held liable for any damage or loss suffered whilst operating, using or connecting to incompatible devices or apps.

The recording and playback of content on this or any other device may require permission from the owner of the copyright or other such rights in that content. It is your responsibility to ensure that your use of this or any other device complies with applicable copyright legislation in your country. Please refer to that legislation for more information on the relevant laws and regulations involved or contact the owner of the rights of the content you wish to record or playback.

**Read these instructions**

**Follow all instructions**

**Heed all warnings**



**Keep these instructions**

All rights reserved.



### Safety Instructions

To ensure safe and correct use of this product, always comply with the following precautions to avoid dangerous situations and damage to your unit:

	<b>CAUTION</b> RISK OF ELECTRIC SHOCK DO NOT OPEN	
<b>CAUTION:</b> TO REDUCE THE RISK OF ELECTRIC SHOCK, DO NOT REMOVE COVER (OR BACK). NO USER-SERVICEABLE PARTS INSIDE. REFER SERVICING TO QUALIFIED SERVICE PERSONNEL.		



The lightning flash with arrowhead symbol, within an equilateral triangle is intended to alert the user to the presence of uninsulated dangerous voltage within the product's enclosure that may be of sufficient magnitude to constitute a risk of electric shock.



The exclamation point within an equilateral triangle is intended to alert the user to the presence of important operating and maintenance (servicing) instructions in the literature accompanying the appliance.



AC voltage: This symbol indicates that the rated voltage marked with the symbol is AC voltage.



Class II product : This symbol indicates that it does not require a safety connection of protective earthing (ground). (For 55")



Class I product: This symbol indicates that it requires a safety connection of protective earthing (ground). (For 65")



## Important Safety Instructions

### The intended use and ambient conditions for this TV

This TV is intended for the rendering of video and audio signals, on a table-top or wall-mounted, in a home or office environment. It must not be used in rooms with a high level of humidity or dust concentration. The warranty is only valid if used as intended by the manufacturer.



#### WARNING

**High humidity and dust concentration may lead to current leaks in the device. To reduce the risk of fire or electrical shock:**

- **Do not expose this unit to rain, moisture, dripping or splashing water, and do not place objects filled with liquids, such as vases, cups, etc. on or over the unit.**
- **Do not touch the TV with wet hands.**
- **Do not expose to direct air-conditioning and keep candles or other naked flames away from the TV at all times.**

If the TV is moved from a cold environment to a hot environment, leave it switched off for at least an hour to avoid condensation. If used outside, make sure it is protected from moisture.

If you notice anything unusual, immediately remove the power plug.

In case of fire, use preferably a CO<sub>2</sub> gas or powder fire extinguisher. If such extinguishers are not accessible, try to isolate the electrical supply before using a water fire extinguisher.

#### WARNING

A television set may fall, causing serious personal injury or death. Many injuries, particularly to children, can be avoided by taking simple precautions such as:

- ALWAYS use cabinets or stands or mounting methods recommended by the manufacturer of the television set.
- ALWAYS use furniture that can safely support the television set.
- ALWAYS ensure the television set is not overhanging the edge of the supporting furniture.
- ALWAYS educate children about the dangers of climbing on furniture to reach the television set or its controls.
- ALWAYS route cords and cables connected to your television so they cannot be tripped over, pulled or grabbed.
- NEVER place a television set in an unstable location.
- NEVER place the television set on tall furniture (for example, cupboards or bookcases) without anchoring both the furniture and television set to a suitable support.
- NEVER place the television set on cloth or other materials that may be located between the television set and supporting furniture.
- NEVER place items that might tempt children to climb, such as toys and remote controls, on the top of the television or furniture on which the television is placed.

If your existing television set is being retained and relocated, the same considerations as above should be applied.

## Important Safety Instructions

### ■ Moving/Transportation

Before moving this TV, disconnect all cables and move in the vertical position only. Grasp the device on the upper and lower edges of the frame.

- Do not press or put stress on the front panel of the TV. It may take two or more people to carry larger TVs.

If you have to briefly lay down the TV, place the unit with its entire front surface lying flat on soft material.

The LED screen is made of glass and can break if is not handled properly. Always wear rubber gloves to carry the unit. If the LED screen is damaged, liquid crystal might leak out. In case of skin contact, immediately rinse thoroughly with water.

### ■ Power Supply

Incorrect voltages can damage the TV. Only connect this unit to a power supply with the correct voltage and frequency noted on the type plate, using the supplied power cable.

The power plug must be easily accessible so that the device can be disconnected at all time. The unit is live, even if in standby mode, as long as the unit is connected to a power outlet.

It is recommended that this unit is placed on a dedicated circuit.

- Do not overload the power outlets by connect too many appliances to the same outlet. Overloaded wall outlets, extension cords, etc. are dangerous and can result in electric shock and fire.

After power off, don't turn it on again in 5 seconds. Frequent switching power supply in a short period of time can cause abnormal TV.

### ■ Power plug and power cable

- Do not touch the power plug with wet hands.
- Do not place heavy objects on the power cable. Route the cable so that it is not kinked or laid over sharp edges, walked on or exposed to chemicals. A power cable with damaged insulation can cause electric shock and fire.
- Pull the power plug, NOT on the cable when disconnecting. The cable can become damaged and cause a short circuit if pulled on.
- Do not place the power cable near a high temperature object.
- Do not move the TV with the power cable plugged into a socket.
- Do not use a damaged or loose power cable, or a damaged socket outlet.
- Do not use any power cords other than the one supplied with this unit.
- MAIN plug on the power cord is used as the disconnect device, the disconnect device and socket-outlet shall be easily accessible.

### ■ Set-up

Check that the location is suitable to bear the load of the TV. Place on a level, sturdy and horizontal base. Ensure that the unit does not hang over the edge of the base when placed in or on furniture. If placed on a cart, use caution when moving to avoid the unit from tipping over.

- Place the unit in a normal upright horizontal position. It must never be operated vertically, lying flat or hanging overhead from the ceiling.
- Place the unit where it is not exposed to direct sunlight or other sources of heat.

## Important Safety Instructions

When mounting the TV on a wall, follow the instructions supplied with the wall-mount, make sure not to install the TV by hanging the power and signal cables on the back of the TV.

### ■ Air ventilation and high temperatures

Install your TV only where there is proper ventilation, and ensure that there is at least 10 cm free space on the sides and 20 cm above the unit for air circulation. Excessive heat and obstruction of ventilation could lead to fire or early failure of some electric components.

- Do not block any ventilation openings with newspapers, tablecloths, curtains, etc.
- Do not dry clothing etc. on top of the unit.
- Take care not to touch the ventilation openings since they may become hot.
- Do not insert foreign objects into the TV through the vents.

### ■ The Stand

- Do not use any stand other than the one supplied with this unit.
- Do not modify or use the stand if it becomes warped or physically damaged.
- During setup, make sure that all the screws are securely tightened.
- Ensure that the TV does not suffer any impact during the attachment of the stand.
- Ensure that children do not climb onto the stand.
- Attach or remove the stand with at least two people.

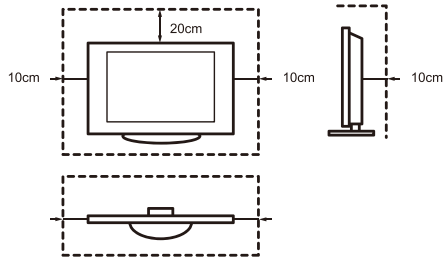

Prevent small items from getting into the interior of the device through the ventilation slots. Such objects may cause short circuits, which may cause fire.

If something should get inside the unit, immediately unplug the power plug of the device and contact service support.

### ■ The LED screen

Despite thorough care when manufacturing this display, it cannot be 100% guaranteed that no sub-pixel defects will occur due to technical reasons. These cannot be considered as a device defect in terms of the guarantee. They will not affect the performance and reliability of the TV.

To prevent "image burn", avoid displaying still images for long periods of time, there is a possibility that a copy of the image may remain. If the aspect ratio is set to 4:3 for a long period of time, image burn may occur on the black areas. Image burn is not covered by the warranty.

- Do not apply strong force or impact on the display panel.

Avoid touching the LED screen or touching it for long periods of time. Doing so may produce some temporary distortion effects on the screen.

## Important Safety Instructions

### ■ Radio waves

- Do not use the TV in any medical institutions or locations with medical equipment. Radio waves may interfere with medical equipment and cause malfunction.
- Do not use the TV near any automatic control equipment such as automatic doors or fire alarms. Radio waves may interfere with automatic control equipment and cause malfunction.

If you have a cardiac pacemaker, keep a distance of at least 22 cm from the TV. Radio waves may interfere with the operation of a pacemaker.

### ■ Built-in wireless LAN

- Do not connect to wireless networks that you do not have the usage rights for. Data transmitted and received over radio waves may be intercepted and monitored.

The built-in wireless LAN uses 2.4 GHz, 5 GHz and 6 GHz frequency band. To avoid malfunctions or slow response caused by radio wave interference, keep the TV away from devices such as other wireless LAN devices, microwaves, mobile phones, and other devices that use 2.4 GHz, 5 GHz and 6 GHz signal.

### ■ Warning about off-gassing

New furniture, carpet, paint, building materials and electronics can release chemicals into the air through evaporation. After you set your TV up and turn it on for the first time, you may notice a slight smell within a couple of hours. This is because some components of TV are heating up for the first time. The materials that we use fully meet the environmental requirements and regulations. Your TV is working just

fine and the fumes from the off-gassing will diminish eventually.

### ■ Supervision

- Do not let children play unsupervised close to the TV. It could tip over, be pushed off or pulled down from the stand surface and injure someone.
- Do not allow a switched-on TV to run unattended.

### ■ Volume

Loud music and noises can lead to irreversible damage to your ears. Avoid extreme volume, especially over long periods and when using headphones.

If you hear a drumming noise in your ears, turn down the volume or temporarily stop using headphones.

### ■ Thunder Storms

Pull out the power plug and all connected antenna cables from the TV during a thunderstorm. Overvoltage caused by lightning strikes can damage the TV via the antenna system, as well as the wall socket.

### ■ Long periods of absence

As long as the power plug is connected to a live socket outlet, the TV will consume power even in standby mode. The power plug and all connected antenna cables should be disconnected out during long periods of absence.

## Important Safety Instructions

### ■ Cleaning and care

#### **CAUTION:**

**Unplug the power cord prior to cleaning the TV.**

Clean the TV, the screen, and the remote control with a soft, moist, clean and colour-natural cloth only. Do not use any chemicals.

- Do not subject the surfaces to insect repellent, solvent, thinner or other volatile substances. This may degrade the surface quality.
- Do not spray water or other liquids directly on the TV. Liquid inside the TV could lead to product failure.
- The surface of the display panel is treated and may be easily damaged. Take care not to scratch it with fingernails or other hard objects.
- Also wipe the power plug with a dry cloth at regular intervals.

### ■ Service/Repair

Never remove the cover/back of the TV; there are no user serviceable parts inside. Refer all service to qualified service personnel.

### ■ Packaging

Keep the anti-moisture materials and plastic bags out of reach of children. Plastic bags can cause suffocation and the anti-moisture material is harmful if

swallowed. If swallowed by mistake, force the patient to vomit and visit the nearest hospital.

### ■ Modification

Do not attempt to modify this product in any way. Unauthorised modification could void the warranty of this unit, cause electric shock and fires.

### ■ Remote Control batteries

- Incorrect installation may cause battery leakage, corrosion and explosion.
- Replace only with the same or equivalent type.
- Do not mix old and new batteries.
- Do not mix different battery types.
- Do not use rechargeable batteries.
- Do not burn or break up batteries.
- Be sure to dispose of batteries correctly.
- Do not expose batteries to excessive heat such as sunshine, fire or the like.

### ■ Outdoor Antenna Grounding

If an outdoor antenna used, be sure the antenna system is protected against voltage surges and built-up static charges.

### ■ Disposal

Refer to the recycling section of this manual.

# Contents



Apparatus with CLASS I construction shall be connected to a MAINS socket outlet with a protective earthing connection. (For 65")

**Figures and illustrations in this manual are provided for reference only and may differ from actual product appearance.**

**Parts of the software function changes with the system upgrade.**

## Contents

---

---

Accessories List.....	1
Installing the Stand or Wall mount bracket.....	2
TV Front.....	5
TV Rear.....	6
Making Connections.....	7
Remote Control.....	10
Turning the TV on for the First Time.....	17
Specifications.....	18
Other Information.....	20

## Accessories List

---

---

The following accessories are included with TV:

User Manual × 1	Screw × 12	Base Stand × 1 (including 2 parts)
AA or AAA Battery × 2	Remote Control × 1	Power Cord × 1
Warranty Card × 1		

### NOTE

- The accessories may be different from the list above due to different models, countries / regions. Please refer to the actual accessory bag.

# Installing the Stand or Wall mount bracket

## ⚠ CAUTION

- Be sure to disconnect the AC power cord before installing a stand or wall mount brackets.
- The display on your TV is fragile. Make sure the TV screen is not scratched or damaged by hard objects or from pressure.
- After the installation is completed, make sure the TV is steady on a table or firmly attached to a wall mount, before removing all protective film, if any.

## ► Installing the stand

Follow the illustrations and instructions below to complete the installation steps:

1. Carefully place your TV face-down on a soft, flat surface to prevent damage to the TV or scratching to the screen.

2. Take out the Base Stand Part A and open it from top, then separate it into Part a1 and Part a2.

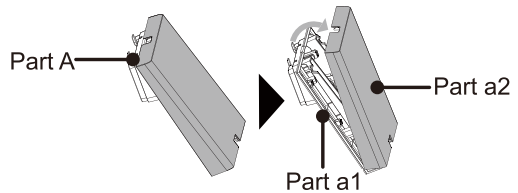

3. Put Part a1 onto the back cover of the TV.

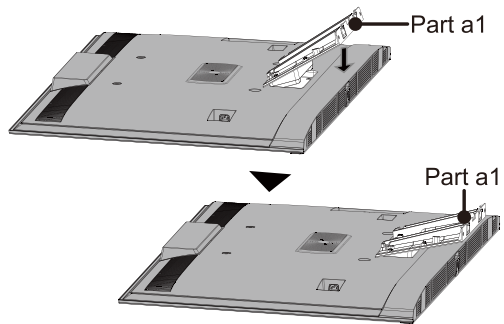

4. Secure Part a1 with 4 screws (M5×12) onto the back cover of the TV.

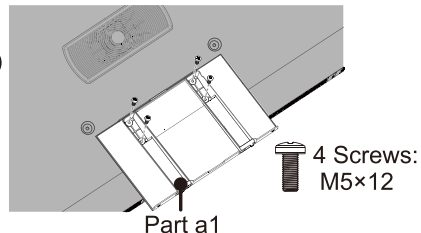

## Installing the Stand or Wall mount bracket

5. Hook Part B to Part a1 as the illustration shows. Please note that the side with 4 pads should be placed outward.

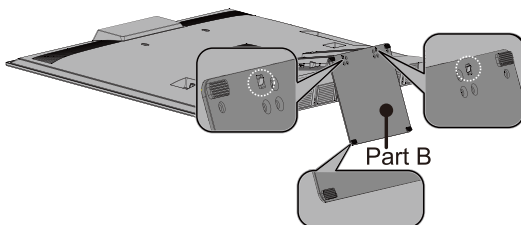

6. Then, secure Part B with 6 screws (M5×16).

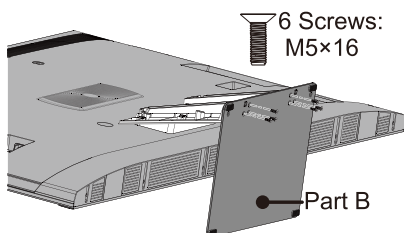

7. Next, secure Part B with 2 screws (ST4×12).

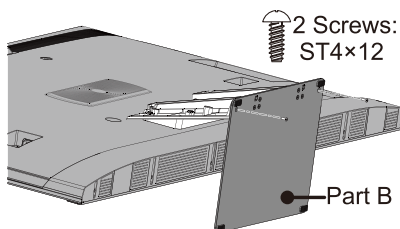

8. You can tidy the cables into slots of Part a1.

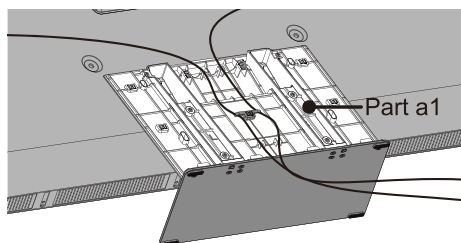

9. Place Part a2 onto Part a1.

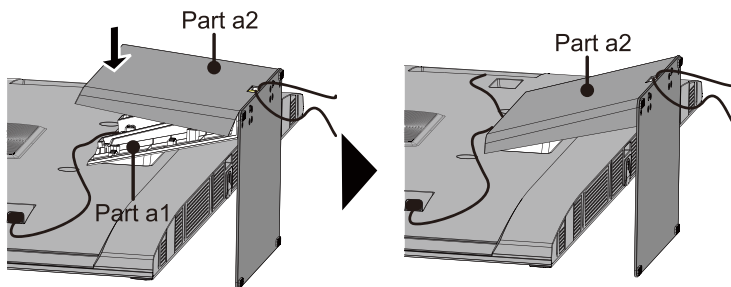



## Installing the Stand or Wall mount bracket

10. Slightly push the centre of the Part a2, then slightly pinch the both sides.

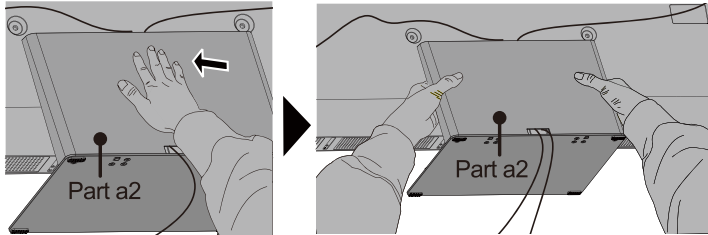

11. Now, you can place the TV on a surface, and tear off all protective film on TV.

### ► Installing the wall mount bracket

Before mounting the TV, remove the TV stand if you have already attached it, and make sure the wall mount bracket supports the weight of your TV.

#### ⚠ CAUTION

When mounting the TV on a wall, follow instructions provided with the wall mount bracket. If it is not correctly mounted, the TV may fall and cause property damage or personal injury.

- Place spacers between the TV and bracket.
- Standard dimensions are shown below.

Wall mount hole pattern (mm)	400 × 300 (55") 400 × 400 (65")
Wall mount screw size	M6

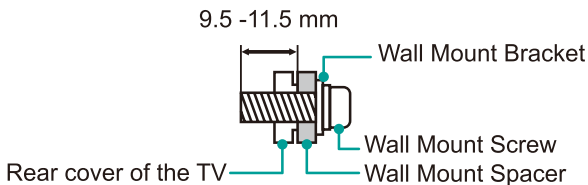

- We do not recommend hanging the TV on a slanted wall, and when wall mounting make sure your television remains parallel to the wall and does not lean forward.

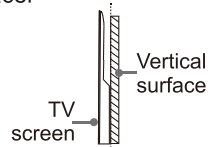

#### 📌 NOTES

- The diameter and length of the screws differ depending on the wall mount bracket model.
- Wall mount bracket is optional. Your TV may not have wall mount bracket. Please refer to the actual accessories.

## TV Front

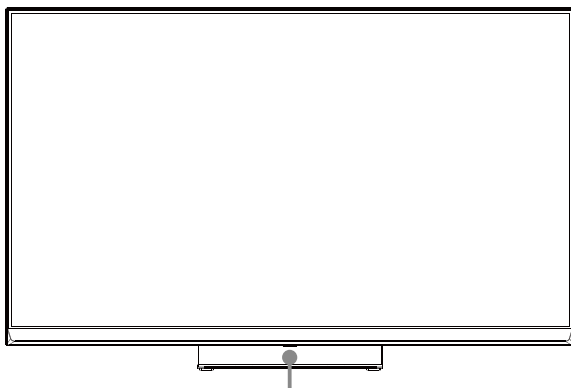

Remote sensor/Light sensor/Power indicator/Single button (Standby/Source)

<i>Item</i>	<i>Description</i>
<b>Remote sensor</b>	Receive remote signals from the remote control. Do not put anything near the sensor, as its function may be affected.
<b>Power indicator</b>	The light is white in standby mode.
 <b>Standby / Source</b>	Press the single button when in standby mode, and the TV will be turned on. Press the single button to call up the menu. When the focus is on "Power Off", wait for 3 seconds, and then the TV will go into standby mode automatically. Press the single button to call up the menu, and then select among the different input signal sources.

### NOTES

- The Picture is Only for Reference.
- Powering on the TV requires several seconds to load programmes. Do not rapidly turn the TV off as it may cause the TV work abnormally.

## TV Rear

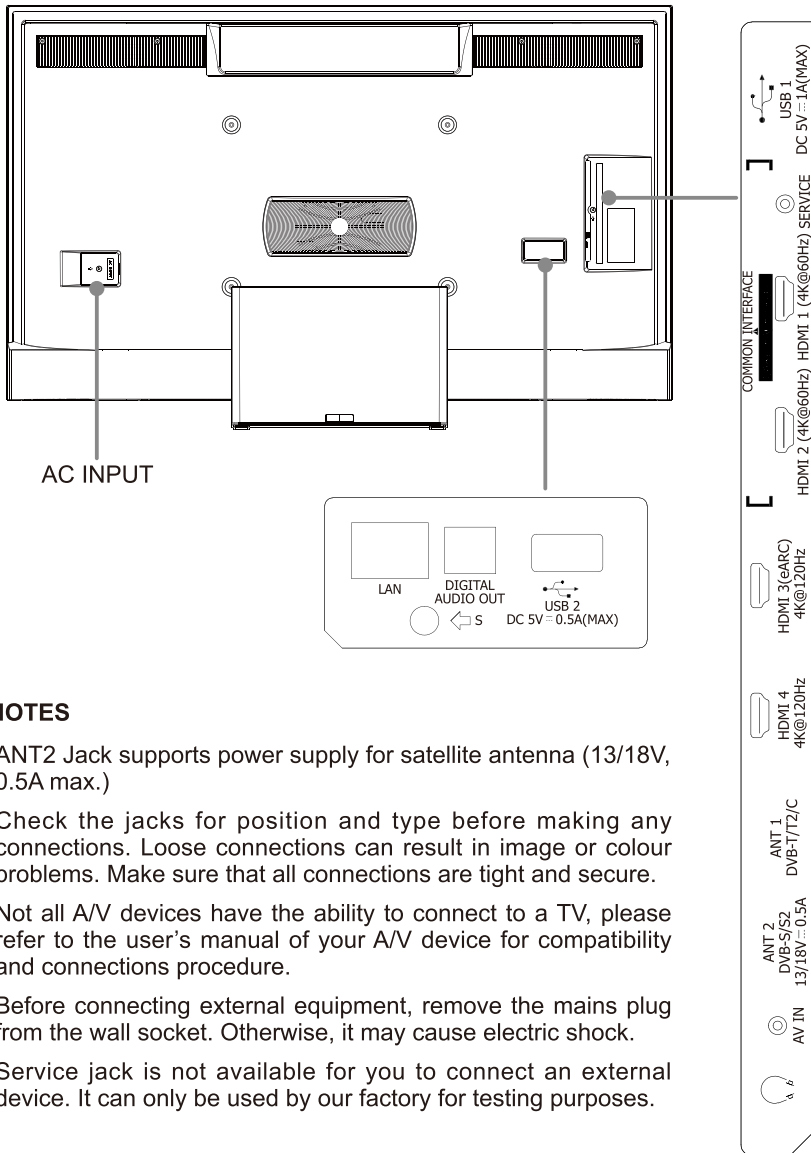

### NOTES

- ANT2 Jack supports power supply for satellite antenna (13/18V, 0.5A max.)
- Check the jacks for position and type before making any connections. Loose connections can result in image or colour problems. Make sure that all connections are tight and secure.
- Not all A/V devices have the ability to connect to a TV, please refer to the user's manual of your A/V device for compatibility and connections procedure.
- Before connecting external equipment, remove the mains plug from the wall socket. Otherwise, it may cause electric shock.
- Service jack is not available for you to connect an external device. It can only be used by our factory for testing purposes.

# Making Connections

## ► LAN (Wired setup)

Connect your TV to your network by connecting the LAN port on the back of your TV to an external modem or router using a LAN (Ethernet/Cat 5) cable. See the illustration below.

- It is recommended to use a modem or router that supports Dynamic Host Configuration Protocol (DHCP). Modems and routers that support DHCP automatically provide the IP address, subnet mask, gateway, and DNS, so you don't have to enter them manually. Most home networks already have DHCP.

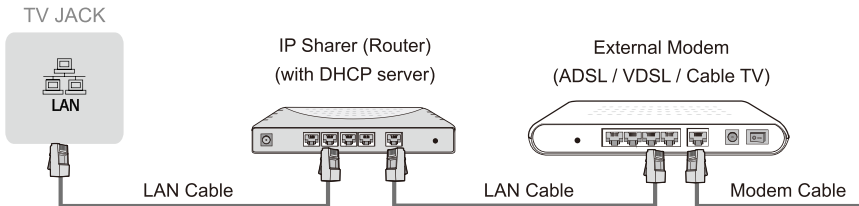

## Wireless setup

To connect your TV to your network wirelessly, you need a wireless router or modem. See the illustration below.



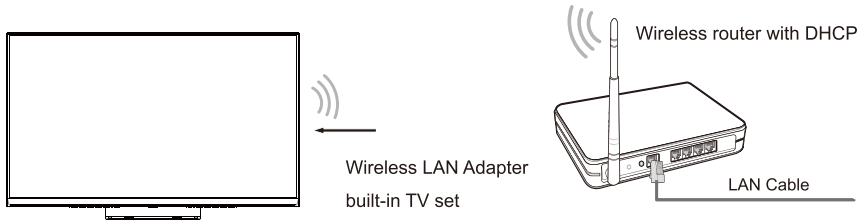







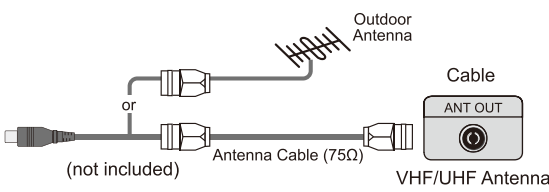
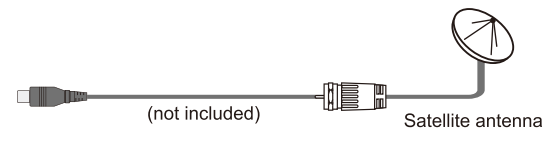

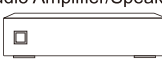

- The built-in Wireless LAN Adapter supports the IEEE 802.11 a/b/g/n/ac/ax communication protocols. It is recommended to use IEEE 802.11ax router. Low transfer rates for b/g may have the influence on the quality of streamed videos and other media.

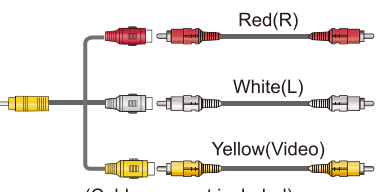

## ☒ NOTES

- You must use the built-in Wireless LAN Adapter to use a wireless network because the set doesn't support external USB network adapters.
- If the wireless router supports DHCP, your TV can connect more easily to the wireless network.
- If you apply a security system other than the systems listed below, it will not work with the TV.  
Security system: WPA, WEP, WPA2.
- In order to guarantee smooth network, the distance between router and TV should be less than 10 metres.

# Making Connections

<p><b>ANT</b></p>	<p>ANT 1 DVB-T/T2/C</p>	 <p>Outdoor Antenna</p> <p>or</p> <p>(not included)</p> <p>Antenna Cable (75Ω)</p> <p>Cable</p> <p>ANT OUT</p> <p>VHF/UHF Antenna</p>	
	<p>ANT 2 DVB-S/S2</p>	 <p>(not included)</p> <p>Satellite antenna</p>	
<p><b>DIGITAL AUDIO OUT</b></p>	 <p>DIGITAL AUDIO OUT</p>	 <p>DIGITAL AUDIO cable (not included)</p>	<p>Audio Amplifier/Speaker</p> 
<p><b>HDMI</b></p>	<p><b>HDMI (eARC)</b></p>  <p>HDMI (eARC)</p>	 <p>HDMI cable (not included)</p>	<p>Audio Amplifier/Speaker</p> 
	<p><b>HDMI</b></p>  <p>HDMI</p>	 <p>HDMI cable (not included)</p>	<p>DVD/Blu-Ray/AV receiver/ Set-top Box</p> 
<p><b>AV IN</b></p>	 <p>AV IN</p>	 <p>Red(R)</p> <p>White(L)</p> <p>Yellow(Video)</p> <p>(Cables are not included)</p>	<p>VCR/DVD Player/ Recorder/Set-top box/ Satellite Receiver/ Video Camera</p> 
<p><b>HEADPHONE</b></p>			<p>Headphone (not included)</p>
<p><b>NOTE</b></p> <ul style="list-style-type: none"> <li>Excessive sound pressure from earphones and headphones can cause hearing loss.</li> </ul>			

## Making Connections

### COMMON INTERFACE



#### NOTES

- Before you insert/remove the CI+ module, ensure that the TV is switched off. Then insert the CI card into the CI+ module in accordance with the Service Provider's instructions.
- Do not repeatedly insert or remove the Common Access Module as this may damage the interface and cause a malfunction.
- You must obtain a CI+ module and card from the service provider of the channels you want to watch.
- Insert the CI+ module with the SmartCard in the direction marked on the module and SmartCard.
- CI+ is not supported in some countries and regions; check with your authorized dealer.

### USB



#### NOTES

- When connecting a hard disk or a USB hub, always connect the mains adapter of the connected device to the power supply. Exceeding a total current consumption may result in damage. The USB 1.1 and USB 2.0 devices maximum current consumption are 500mA. The USB 3.0 device maximum current consumption is 1A.
- For individual non-standard high-capacity mobile hard disk, if its impulse current is greater than or equal 1A, it may cause TV-rebooting or self-locking. So the TV does not support it.
- The USB port supports a voltage of 5V.

# Remote Control

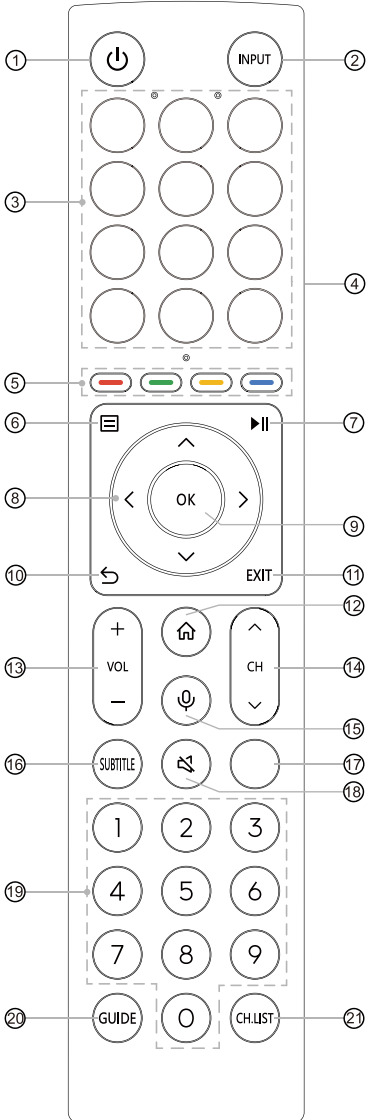

- ① POWER: Switch the TV on or into standby mode
- ② INPUT: Select input sources
- ③ APP: Quick access buttons to apps  
EDIT: Custom to launch input or app
- ④ Physical Switch (Side view): Turn on to activate hands-free wake-up feature\*
- ⑤ Special function buttons
- ⑥ : Display the Quick setup menu
- ⑦ : Media content control function button
- ⑧ : Allow you to navigate the on-screen menus and adjust the system settings to your preference
- ⑨ OK: Confirm the selection in the on-screen menus
- ⑩ BACK: Return to previous menu
- ⑪ EXIT: Exit the menu
- ⑫ HOME: Enter the Home screen
- ⑬ VOL + / -: Adjust the volume
- ⑭ CH / : Switch channel
- ⑮ MIC: Activate the microphone
- ⑯ SUBTITLE: Activate or deactivate the subtitle mode
- ⑰ INFO: Display the present programme information  
TEXT: Turn on/off the teletext function
- ⑱ MUTE: Mute or restore the TV sound
- ⑲ Number buttons: Direct channel selection or numbers input
- ⑳ GUIDE: Display the Electronic Programme Guide (DTV mode)
- ㉑ CH.LIST: Display the Channel List on the screen

## Bluetooth remote control module specifications

XF2472C  
 Frequency Range: 2.400GHz~2.4835GHz  
 Output Power(Max.): +4dBm

\*When you do not use hands-free wake-up, please turn off the physical switch to lengthen the battery life.

**NOTE:** The included remote control will vary depending on model, countries/regions. Check information according to the actual remote control in the accessory bag.

# Remote Control

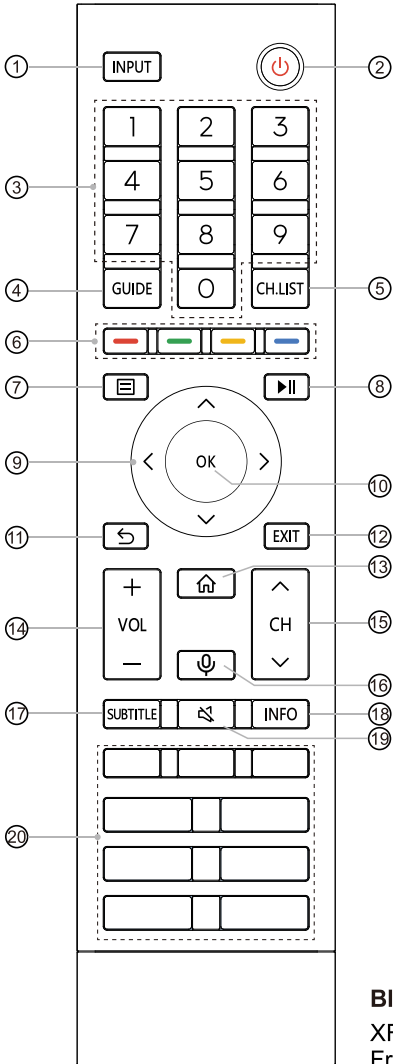

- ① INPUT: Select input sources
- ② POWER: Switch the TV on or into standby mode
- ③ Number buttons: Direct channel selection or numbers input
- ④ GUIDE: Display the Electronic Programme Guide (DTV mode)
- ⑤ CH.LIST: Display the Channel List on the screen
- ⑥ Special function buttons
- ⑦ : Display the Quick setup menu
- ⑧ : Media content control function button
- ⑨ : Allow you to navigate the on-screen menus and adjust the system settings to your preference
- ⑩ OK: Confirm the selection in the on-screen menus
- ⑪ BACK: Return to previous menu
- ⑫ EXIT: Exit the menu
- ⑬ HOME: Enter the Home screen
- ⑭ VOL + / -: Adjust the volume
- ⑮ CH / : Switch channel
- ⑯ MIC: Activate the microphone
- ⑰ SUBTITLE: Activate or deactivate the subtitle mode
- ⑱ INFO: Display the present programme information
- ⑲ MUTE: Mute or restore the TV sound
- ⑳ APP: Quick access to the app  
 MEDIA: Enter the media mode  
: All Apps  
 BROWSER: Enter into BROWSER

## Bluetooth remote control module specifications

XF2472C

Frequency Range: 2.400GHz~2.4835GHz

Output Power(Max.): +4dBm

**NOTE:** The included remote control will vary depending on model, countries/regions. Check information according to the actual remote control in the accessory bag.



## Remote Control

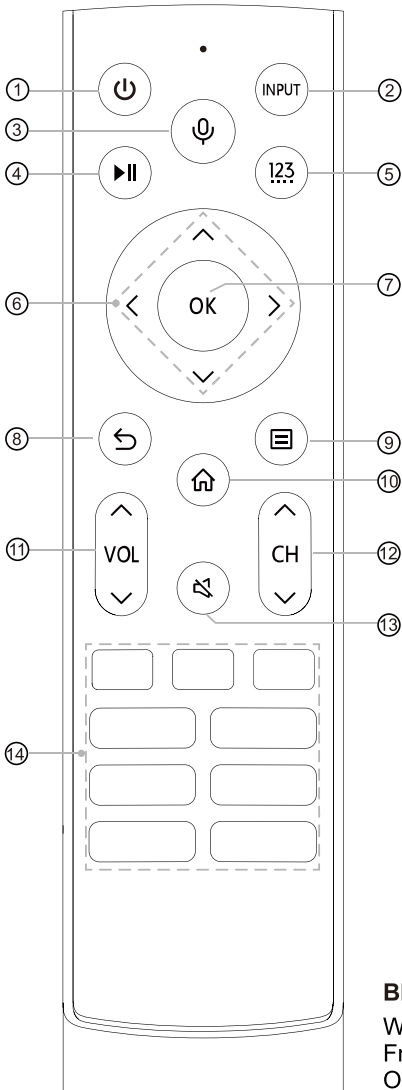

- ① ⏻: Switch the TV on or into standby mode
- ② INPUT: Select input sources
- ③ 🎤: Activate the microphone
- ④ ⏸: Media content control function button
- ⑤ 123: Enter Channels / input numbers and special function buttons (Red/Green/Yellow/Blue)
- ⑥ ▲ / ▼ / ◀ / ▶: Allow you to navigate the on-screen menus and adjust the system settings to your preference
- ⑦ OK: Confirm the selection in the on-screen menus
- ⑧ ↶: Return to previous menu
- ⑨ ☰: Display the Quick setup menu
- ⑩ 🏠: Enter the Home screen
- ⑪ VOL ▲ / ▼: Adjust the volume
- ⑫ CH ▲ / ▼: Switch channel
- ⑬ 🔇: Mute and restore sound
- ⑭ APP: Quick access buttons to apps  
MEDIA: Enter the media mode

### Bluetooth remote control module specifications

WNF171

Frequency Range: 2.400GHz~2.4835GHz

Output Power(Max.): +4.5dBm

**NOTE:** The included remote control will vary depending on model, countries/regions. Check information according to the actual remote control in the accessory bag.

## Remote Control

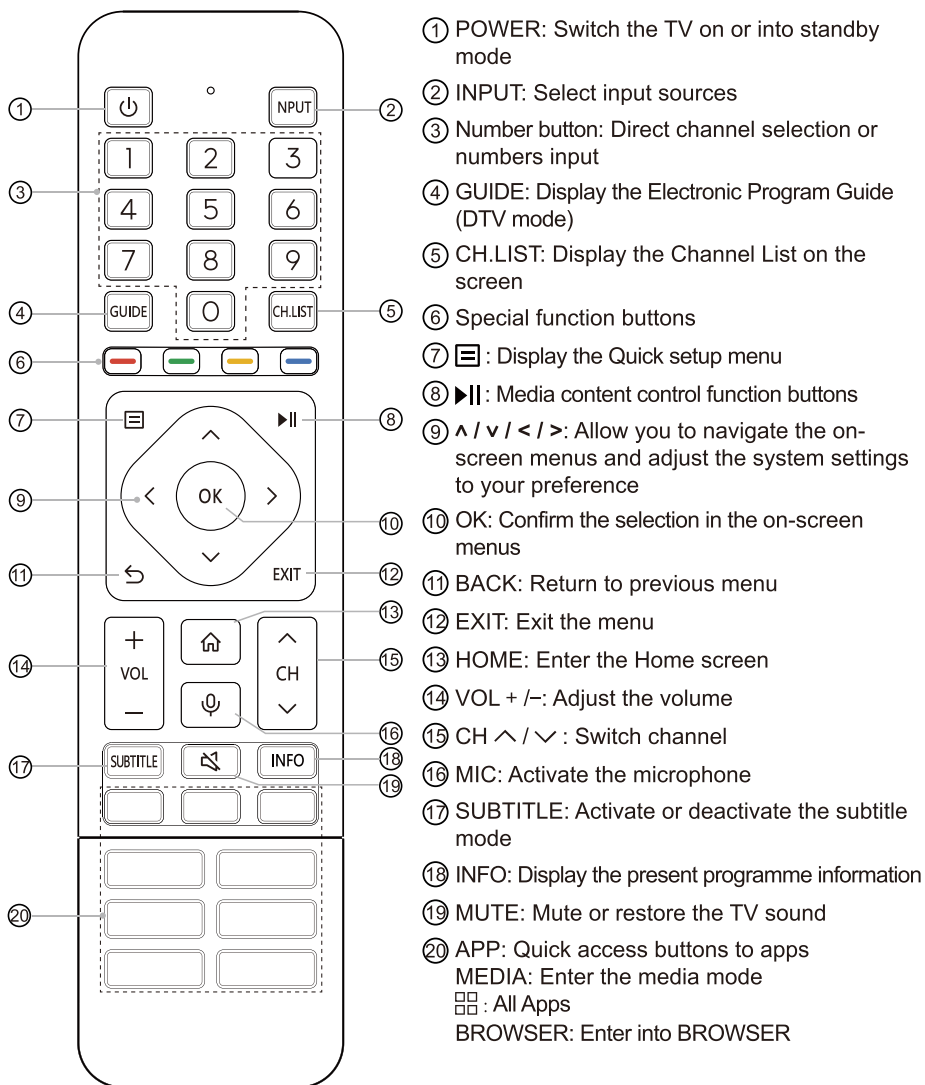

### Bluetooth remote control module specifications

XF2472C

Frequency Range: 2.400GHz~2.4835GHz

Output Power(Max.): +4dBm

**NOTE:** The included remote control will vary depending on model, countries/regions. Check information according to the actual remote control in the accessory bag.

## Remote Control

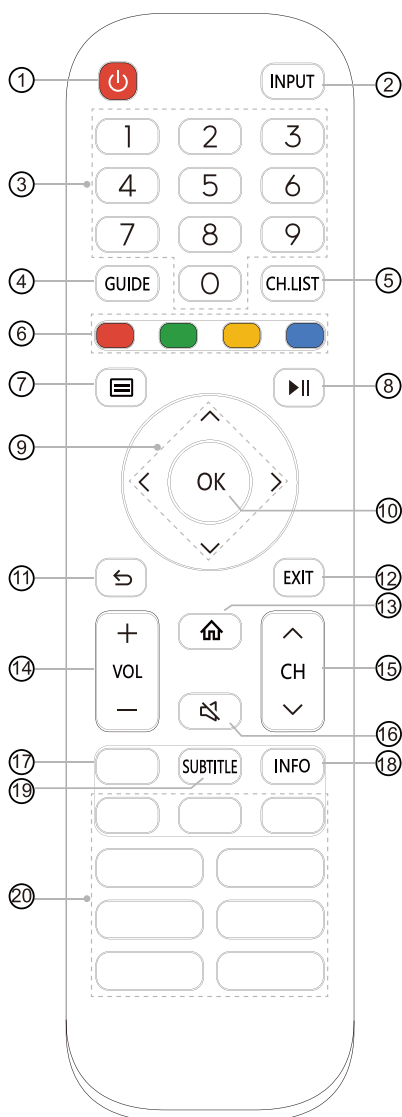

- ① POWER: Switch the TV on or into standby mode
- ② INPUT: Select input sources
- ③ Number buttons: Direct channel selection or numbers input
- ④ GUIDE: Display the Electronic Programme Guide (DTV mode)
- ⑤ CH.List: Display the Channel List on the screen
- ⑥ Special function buttons
- ⑦ ☰: Display the Quick setup menu
- ⑧ ►||: Media content control function buttons
- ⑨ ^ / v / < / >: Allow you to navigate the on-screen menus and adjust the system settings to your preference
- ⑩ OK: Confirm the selection in the on-screen menus
- ⑪ BACK: Return to previous menu
- ⑫ EXIT: Exit the menu
- ⑬ HOME: Enter the Home screen
- ⑭ VOL + / -: Adjust the volume
- ⑮ CH ^ / v: Switch channel
- ⑯ MUTE: Mute or restore the TV sound
- ⑰ TXT/TEXT: Turn on/off the teletext function
- ⑱ INFO: Display the present programme information
- ⑲ SUBTITLE: Activate or deactivate the subtitle mode
- ⑳ APP: Quick access buttons to apps  
MEDIA: Enter the media mode

**NOTE:** The included remote control will vary depending on model, countries/regions. Check information according to the actual remote control in the accessory bag.

## Remote Control

### ► Installing Batteries in the Remote Control

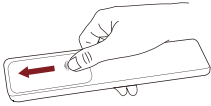

1. Slide the back cover to open the battery compartment of the remote control.

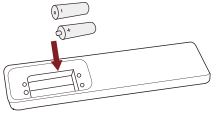

2. Insert two AA or AAA size batteries. Make sure to match the (+) and (-) ends of the batteries with the (+) and (-) ends indicated in the battery compartment.

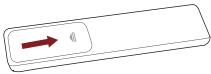

3. Close the battery compartment with the cover.

### ☒ NOTES

- Product image is only for reference, actual product may vary in appearance.

#### Handling the Batteries

- Incorrect use of batteries may cause corrosion or battery leakage, which could cause fire, personal injury or damage to property.
- Only use the battery type indicated in this manual. Whether to use AA or AAA size batteries, please refer to the actual remote control.
- Do not mix old and new batteries or different types of batteries.
- Do not dispose of used batteries as domestic waste. Dispose of them in accordance with local regulations.

### ► Pairing the Remote Control (only for Bluetooth remote control)

Pair the remote to the TV after you power it on. Keep the remote control within 3 metres from the TV. Press any button (except power and mic button) to pair.

### ☒ NOTES

- In special cases, press and hold [  ] button to pair.
- If an unknown error occurred with the remote, then it could have been caused by interference. Try to remove what's causing the interference and pair it again.
- If an unknown error occurred in the remote control while the battery power is normal, you can take out the batteries, press any key for 1~2 seconds, and insert them back. Then the remote control will work normally.
- The remote cannot be paired to the TV while the TV is in standby mode.

### ► Remote Control Operation Range

1. The remote control can work at a distance of up to 8 metres in front of the TV set.
2. The remote control angle: taking the remote sensor as an apex, its controlled horizontal angle is within  $\pm 30^\circ$ , while the vertical angle is within  $\pm 15^\circ$ .
3. The operating distance may vary depending on the brightness of the room.

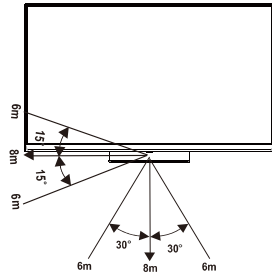

### Disposal of this unit

Product should not be damaged, dismantled or thrown in municipal waste. It should be packed and handed over to authorised re-cycler.

## Turning the TV on for the First Time

### Turning the TV on for the First Time

1. Connect the mains cable to the mains socket after you have completed all the connections.
2. The first time you turn the TV on, it will go straight into the Installation Guide.
3. Press the [ ^ / v / < / > ] buttons to navigate the menu and change the settings. Press the [OK] button to confirm.

<b>Select your Language</b>	Select your desired language to be displayed on the menu. Press menu button to set up your TV for store mode.
<b>Set up on Mobile or Set up on TV</b>	Set up with the smart device by scanning the QR code to download the mobile app, or continue on TV.
<b>Connect to the Internet</b>	Connect you to your favourite apps, movies, and programmes on the Internet through WLAN.
<b>Select your Location</b>	Knowing your location will help us tailor recommended contents for you.
<b>Terms &amp; Conditions, Privacy Policy</b>	Your use of this device is subject to the End User License Agreement, and lack of your acceptance of the End User License Agreement will turn off all smart features of this device. Please read the details carefully before you choose.
<b>Sign in to your VIDAA Account</b>	With a VIDAA account, you can manage your content preferences, subscriptions and more.
<b>Select your Voice Assistant</b>	Select your voice assistant you want to use on the TV.
<b>Name your TV</b>	Give your TV a unique name to help identify it when casting or connecting to it from other devices.
<b>Welcome to VIDAA</b>	Congratulations, you have finished the set-up. Choose from the selections on screen to get started according to your preferences.

**NOTE:** The Guide above is for referencing purpose and may differ depending on models/countries/regions.

## Specifications

☑ Features, appearance and specifications are subject to change without notice.

Item		55"	65"
Dimension (W × H × D)	Without Stand	48.5 × 28.9 × 3.0 inches (1233 × 734 × 77 mm)	57.2 × 33.8 × 3.1 inches (1452 × 858 × 78 mm)
	With Stand	48.5 × 30.9 × 11.8 inches (1233 × 784 × 300 mm)	57.2 × 36.0 × 11.8 inches (1452 × 914 × 300 mm)
Weight	Without Stand	42.8 lbs (19.4 kg)	58.4 lbs (26.5 kg)
	With Stand	54.0 lbs (24.5 kg)	69.4 lbs (31.5 kg)
Active Screen Size (Diagonal)		139 cm	164 cm
Screen resolution		3840 × 2160	
Audio power		4×10W+20W+2×5W	4×10W+20W+2×5W
Operating mode power density		0.028 Watts/cm <sup>2</sup>	0.025 Watts/cm <sup>2</sup>
Power consumption when turned off		N.A.	
Power consumption in standby mode		0.5 W	
Power consumption		Please refer to the rating label.	
Power supply		Please refer to the rating label.	
Receiving systems	Analogue	PAL-D/K, B/G, I, SECAM-D/K, B/G	
	Digital	DVB-T/T2, DVB-C, DVB-S/S2	
Wireless LAN Module specifications	Model	TX7921AU64T	
	Frequency Range	2.4-2.4835GHz 5.15-5.85GHz 5.9-6.425GHz	
	Output Power (Max.)	2.4-2.4835GHz 17dBm 5.15-5.25GHz 14dBm 5.25-5.35GHz(DFS Band) 14dBm 5.49-5.71GHz(DFS/TPC Band) 14dBm 5.725-5.85GHz(for Non EU) 14dBm 5.9-6.425GHz 14dBm	
Bluetooth Module specifications	Model	TX7921AU64T	
	Frequency Range	2.4-2.4835GHz	
	Output Power (Max.)	2.4-2.4835GHz, Class1, 6dBm	

## Specifications

<b>Environmental conditions</b>	Temperature: 41°F - 95°F (5°C - 35°C) Humidity: 20% - 80% RH Atmospheric pressure: 86 kPa - 106 kPa
<b>HDMI Input</b>	RGB / 60Hz (640×480, 800×600, 1024×768) YUV / 60Hz (480i, 480p, 720p, 1080i, 1080p) YUV / 50Hz (576i, 576p, 720p, 1080i, 1080p) 3840×2160 / 24Hz, 3840×2160 / 25Hz, 3840×2160 / 30Hz, 3840×2160 / 50Hz, 3840×2160 / 60Hz For HDMI 3, 4: 3840×2160 / 120Hz, 2560×1440 / 120Hz, 1920×1080 / 120Hz

### EPREL Registration Information

Model identifier	Eprel registration number	Model identifier	Eprel registration number
55U8HQ	1126737	65U8HQ	1123880
55U80HQ	1126759	65U80HQ	1125163
55U81HQ	1126766	65U81HQ	1125166
55U82HQ	1126813	65U82HQ	1125169
55U8HQCH	1126828	65U8HQCH	1125171
55U80HQCH	1126835	65U80HQCH	1125174
55U88HQNE	1126853	65U88HQNE	1125175
55U86HQ	1126860	65U86HQ	1125178
55U87HQ	1126870	65U87HQ	1125180
55U88HQ	1126895	65U88HQ	1125182
55U89HQ	1126902	65U89HQ	1125184
55U86HQCH	1126906	65U86HQCH	1125186
55U87HQCH	1126910	65U87HQCH	1125188
55U89HQNE	1126920	65U89HQNE	1125189
55U8HQTUK	1126925	65U8HQTUK	1125190
55U80HQTUK	1126929	65U80HQTUK	1125191
55U81HQTUK	1126933	65U81HQTUK	1125193
55U82HQTUK	1126938	65U82HQTUK	1125195
55U86HQTUK	1126955	65U86HQTUK	1125196
55U87HQTUK	1126959	65U87HQTUK	1125197



### Recycling/Licenses

#### WEEE (Waste Electronic Electric Equipment) European Directive 2012/19/EU

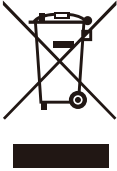

This symbol on the product or on its packaging indicates that this product must not be disposed of with your household waste. Instead, it is your responsibility to dispose of your waste equipment by handing it over to a designated collection point for the recycling of waste electrical and electronic equipment. The separate collection and recycling of your waste equipment at the time of disposal will help to conserve natural resources and ensure that it is recycled in a manner that protects human health and the environment. For more information about where you can drop off your waste equipment for recycling, please contact your local city office, your household waste disposal service or the shop where you purchased the product.

#### Batteries



In accordance with the Battery Directive, used batteries should not be disposed of in the domestic waste. Dispose your batteries in the collection containers specific for this purpose in retail stores.

#### ROHS (Restriction of Hazardous Substance) European Directive 2011/65/EU



This European directive limits the use of dangerous and hazardous substances which are difficult to recycle.

This allows recycling easily the EEE and contributes to the safeguard of the environment.

Substances included in this product match to the RoHS directive.



The terms HDMI and HDMI High-Definition Multimedia Interface, and the HDMI Logo are trademarks or registered trademarks of HDMI Licensing Administrator, Inc. in the United States and other countries.



Dolby, Dolby Vision, Dolby Atmos, and the double-D symbol are registered trademarks of Dolby Laboratories Licensing Corporation. Dolby Vision IQ is a trademark of Dolby Laboratories Licensing Corporation. Manufactured under license from Dolby Laboratories. Confidential unpublished works. Copyright © 2012-2021 Dolby Laboratories. All rights reserved.



For DTS patents, see <http://patents.dts.com>. Manufactured under license from DTS Licensing Limited. DTS, DTS-HD Master Audio, DTS-HD, Virtual:X, and the DTS-HD logo are registered trademarks or trademarks of DTS, Inc. in the United States and other countries. © 2021 DTS, Inc. ALL RIGHTS RESERVED.



Manufactured under license from IMAX Corporation. IMAX® is a registered trademark of IMAX Corporation in the United States and/or other countries. For DTS patents, see <http://patents.dts.com>. Manufactured under license from DTS Licensing Limited. DTS and the DTS logo are registered trademarks or trademarks of DTS, Inc. in the United States and other countries. © 2020 DTS, Inc. ALL RIGHTS RESERVED.

### SIMPLIFIED EU DECLARATION OF CONFORMITY

Hereby, Hisense Visual Technology Co., Ltd. declares that the radio equipment type [ERF3A86 / ERF3B86H / ERF3C86H / ERF3D86H / ERF3E86H / ERF3F86H / ERF3G86H / ERF3N80H / ERF3M80H / ERF3F90H / ERF3A52 / 55U8HQ / 55U80HQ / 55U81HQ / 55U82HQ / 55U8HQCH / 55U80HQCH / 55U88HQNE / 55U86HQ / 55U87HQ / 55U88HQ / 55U89HQ / 55U86HQCH / 55U87HQCH / 55U89HQNE / 55U8HQTUK / 55U80HQTUK / 55U81HQTUK / 55U82HQTUK / 55U86HQTUK / 55U87HQTUK / 65U8HQ / 65U80HQ / 65U81HQ / 65U82HQ / 65U8HQCH / 65U80HQCH / 65U88HQNE / 65U86HQ / 65U87HQ / 65U88HQ / 65U89HQ / 65U86HQCH / 65U87HQCH / 65U89HQNE / 65U8HQTUK / 65U80HQTUK / 65U81HQTUK / 65U82HQTUK / 65U86HQTUK / 65U87HQTUK] is in compliance with Directive 2014/53/EU. The full text of the EU declaration of conformity is available at the following internet address: <https://global.hisense.com/support/certificate-download/>.

For Great Britain:

### SIMPLIFIED UK DECLARATION OF CONFORMITY

Hereby, Hisense Visual Technology Co., Ltd. declares that the radio equipment type [ERF3A86 / ERF3B86H / ERF3C86H / ERF3D86H / ERF3E86H / ERF3F86H / ERF3G86H / ERF3N80H / ERF3M80H / ERF3F90H / ERF3A52 / 55U8HQ / 55U80HQ / 55U81HQ / 55U82HQ / 55U8HQCH / 55U80HQCH / 55U88HQNE / 55U86HQ / 55U87HQ / 55U88HQ / 55U89HQ / 55U86HQCH / 55U87HQCH / 55U89HQNE / 55U8HQTUK / 55U80HQTUK / 55U81HQTUK / 55U82HQTUK / 55U86HQTUK / 55U87HQTUK / 65U8HQ / 65U80HQ / 65U81HQ / 65U82HQ / 65U8HQCH / 65U80HQCH / 65U88HQNE / 65U86HQ / 65U87HQ / 65U88HQ / 65U89HQ / 65U86HQCH / 65U87HQCH / 65U89HQNE / 65U8HQTUK / 65U80HQTUK / 65U81HQTUK / 65U82HQTUK / 65U86HQTUK / 65U87HQTUK] is in compliance with Directive 2014/53/EU. The full text of the EU declaration of conformity is available at the following internet address: <https://global.hisense.com/support/certificate-download/>.