



ZLS3481W

en

**Instruction Manual**



## Please read these instructions first before using your appliance

Thank you for choosing a Beko appliance.

Please take some time to read this user manual before using your appliance, to ensure you know how to safely operate the controls and functions.

Carefully follow all unpacking and installation instructions to ensure the appliance is correctly connected and fitted prior to use.



Please write your product model and serial number on the last page of this user manual, and store in a safe location close to the appliance for easy future reference.



This user manual may also be applicable for several other models. Differences between models will be listed.

If you have any questions or concerns, please call our contact centre or find help and information online at [www.beko.co.uk](http://www.beko.co.uk)

### Symbols and their descriptions

This instruction manual contains the following symbols:

-  Important information or useful usage tips.
-  Warning against dangerous conditions for life and property.
-  Warning against electric voltage.

 <b>INFORMATION</b>	
 <b>SUPPLIER'S NAME</b> A	 <b>MODEL IDENTIFIER</b> → (*) A  <a href="https://eprel.ec.europa.eu/">https://eprel.ec.europa.eu/</a>

---

<b>1 Your refrigerator</b>	<b>4</b>	<b>4 Preparation</b>	<b>14</b>
<b>2 Safety and Environment Instructions</b>	<b>5</b>	<b>5 Using your refrigerator</b>	<b>15</b>
General Safety .....	5	Using interior compartments.....	15
Intended Use .....	8	Cooling .....	15
Child Safety .....	8	Stopping your product .....	16
Compliance with WEEE Directive and Disposing of the Waste Product .....	8	Defrosting .....	16
Compliance with RoHS Directive.....	8	<b>6 Maintenance and cleaning</b>	<b>17</b>
Package Information .....	8	<b>7 Do's and don'ts</b>	<b>18</b>
<b>3 Installation</b>	<b>9</b>		
Points to be considered when re-transporting your refrigerator .....	9		
Before operating your refrigerator ....	9		
Electric connection .....	10		
Disposing of the packaging.....	10		
Disposing of your old refrigerator ....	10		
Placing and Installation.....	10		
Adjusting the feet .....	11		
Changing the illumination lamp .....	11		
Reversing the doors .....	12		
Reversing the door .....	13		

# 1 Your refrigerator

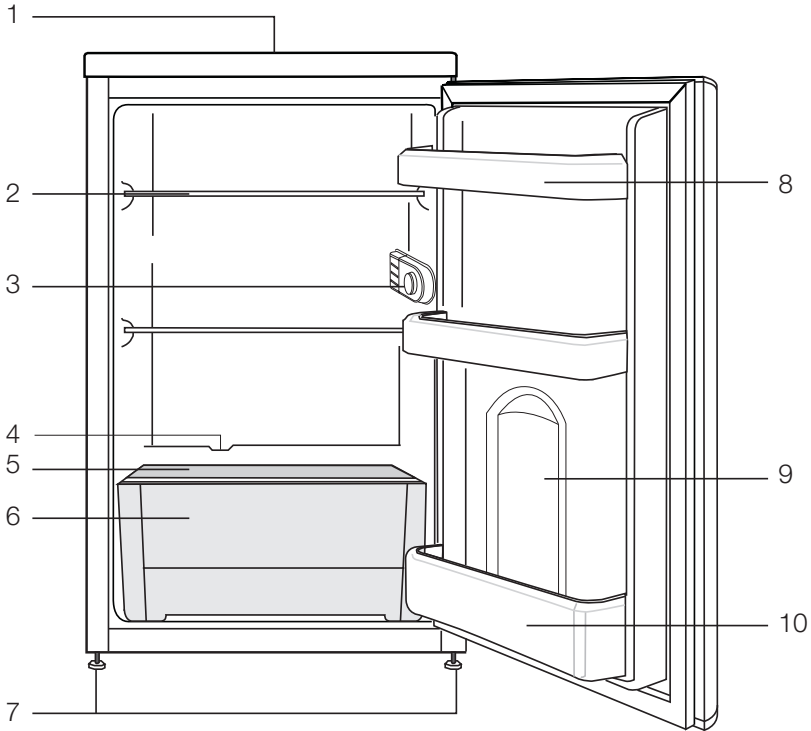





1. Top trim
2. Movable shelves
3. Interior light & Thermostat knob
4. Defrost water collection channel - Drain tube
5. Crisper cover
6. Crisper
7. Adjustable front feet
8. Door shelves
9. 2L Bottle storage position
10. Bottle shelf

**f** Figures that take place in this instruction manual are schematic and may not correspond exactly with your product. If the subject parts are not included in the product you have purchased, then it is valid for other models.

This section provides the safety instructions necessary to prevent the risk of injury and material damage. Failure to observe these instructions will invalidate all types of product warranty.

### Intended use

	<p><b>WARNING:</b> Keep ventilation openings, in the appliance enclosure or in the built-in structure, clear of obstruction.</p>
	<p><b>WARNING:</b> Do not use mechanical devices or other means to accelerate the defrosting process, other than those recommended by the manufacturer.</p>
	<p><b>WARNING:</b> Do not damage the refrigerant circuit.</p>
	<p><b>WARNING:</b> Do not use electrical appliances inside the food storage compartments of the appliance, unless they are of the type recommended by the manufacturer.</p>
	<p><b>WARNING:</b> Do not store explosive substances such as aerosol cans with a flammable propellant in this appliance.</p>

### General Safety

- This product should not be used by persons with physical, sensory and mental disabilities, without sufficient knowledge and experience or by children. The device can only be used by such persons under supervision and instruction of a person responsible for their safety. Children should not be allowed to play with this device.
- In case of malfunction, unplug the device.
- After unplugging, wait at least 5 minutes before plugging in again.
- Unplug the product when not in use.
- Do not touch the plug with wet hands! Do not pull the cable to plug off, always hold the plug.
- Do not plug in the refrigerator if the socket is loose.
- Unplug the product during installation, maintenance, cleaning and repair.
- If the product will not be used for a while, unplug the product and remove any food inside.
- Do not use the product when the compartment with circuit cards located on the upper back part of the product (electrical card box cover) (1) is open.

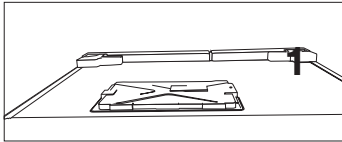
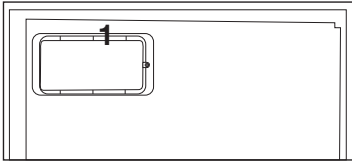

- Do not use steam or steamed cleaning materials for cleaning the refrigerator and melting the ice inside. Steam may come into contact with the electrified areas and cause short circuit or electric shock!
- Do not wash the product by spraying or pouring water on it! Danger of electric shock!
- In case of malfunction, do not use the product, as it may cause electric shock. Contact the authorized service before doing anything.
- Plug the product into an earthed socket. Earthing must be done by a qualified electrician.
- If the product has LED type lighting, contact the authorized service for replacing or in case of any problem.
- Do not touch frozen food with wet hands! It may adhere to your hands!
- Do not place liquids in bottles and cans into the freezer compartment. They may burst out!
- Place liquids in upright position after tightly closing the lid.
- Do not spray flammable substances near the product, as it may burn or explode.

- Do not keep flammable materials and products with flammable gas (sprays, etc.) in the refrigerator.
- Do not place containers holding liquids on top of the product. Splashing water on an electrified part may cause electric shock and risk of fire.
- Exposing the product to rain, snow, sunlight and wind will cause electrical danger. When relocating the product, do not pull by holding the door handle. The handle may come off.
- Take care to avoid trapping any part of your hands or body in any of the moving parts inside the product.
- Do not step or lean on the door, drawers and similar parts of the refrigerator. This will cause the product to fall down and cause damage to the parts.
- Take care not to trap the power cable.

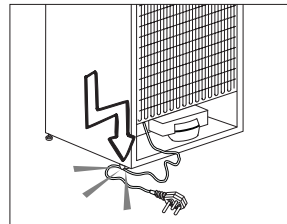

- When positioning the appliance, ensure the supply cord is not trapped or damaged.
- Do not locate multiple portable socket-outlets or portable power supplies at the rear of the appliance.
- Children aged from 3 to 8 years are allowed to load and unload

refrigerating appliances.

- To avoid contamination of food, please respect the following instructions:
  - Opening the door for long periods can cause a significant increase of the temperature in the compartments of the appliance.
  - Clean regularly surfaces that can come in contact with food and accessible drainage systems.
  - Clean water tanks if they have not been used for 48 h; flush the water system connected to a water supply if water has not been drawn for 5 days.
  - Store raw meat and fish in suitable containers in the refrigerator, so that it is not in contact with or drip onto other food.
  - Two-star frozen-food compartments are suitable for storing pre-frozen food, storing or making icecream and making ice cubes.
  - One-, two- and three-star compartments are not suitable for the freezing of fresh food.
  - If the refrigerating appliance is left empty for long periods, switch off, defrost, clean, dry, and leave the door open to prevent mould developing within the appliance.

### 1.1.1 HC Warning

If the product comprises a cooling system using R600a gas, take care to avoid damaging the cooling system and its pipe while using and moving

the product. This gas is flammable. If the cooling system is damaged, keep the product away from sources of fire and ventilate the room immediately.



The label on the inner left side indicates the type of gas used in the product.

### 1.1.2 For Models with Water Dispenser

- Pressure for cold water inlet shall be maximum 90 psi (6.2 bar). If your water pressure exceeds 80 psi (5.5 bar), use a pressure limiting valve in your mains system. If you do not know how to check your water pressure, ask for the help of a professional plumber.
- If there is risk of water hammer effect in your installation, always use a water hammer prevention equipment in your installation. Consult Professional plumbers if you are not sure that there is no water hammer effect in your installation.
- Do not install on the hot water inlet. Take precautions against of the risk of freezing of the hoses. Water temperature operating interval shall be 33°F (0.6°C) minimum and 100°F (38°C) maximum.
- Use drinking water only.

### Intended Use

- This product is designed for home use. It is not intended for commercial use.

- The product should be used to store food and beverages only.
- Do not keep sensitive products requiring controlled temperatures (vaccines, heat sensitive medication, medical supplies, etc.) in the refrigerator.
- The manufacturer assumes no responsibility for any damage due to misuse or mishandling.
- Original spare parts will be provided for 10 years, following the product purchasing date.

## Child Safety

- Keep packaging materials out of children's reach.
- Do not allow the children to play with the product.
- If the product's door comprises a lock, keep the key out of children's reach.

## Compliance with WEEE Directive and Disposing of the Waste Product

This product complies with EU WEEE Directive (2012/19/EU). This product bears a classification symbol for waste electrical and electronic equipment (WEEE).

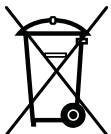

This product has been manufactured with high quality parts and materials which can be reused and are suitable for recycling. Do not dispose of the waste product with normal domestic and other wastes at the end of its service life. Take it to the collection center for the recycling of

electrical and electronic equipment. Please consult your local authorities to learn about these collection centers.

## Compliance with RoHS Directive

- This product complies with EU WEEE Directive (2011/65/EU). It does not contain harmful and prohibited materials specified in the Directive.

## Package Information

Packaging materials of the product are manufactured from recyclable materials in accordance with our National Environment Regulations. Do not dispose of the packaging materials together with the domestic or other wastes. Take them to the packaging material collection points designated by the local authorities.



## 3 Installation

⚠ Please remember that the manufacturer shall not be held liable if the information given in the instruction manual is not observed.

### Points to be considered when re-transporting your refrigerator

1. Your refrigerator must be emptied and cleaned prior to any transportation.
2. Shelves, accessories, crisper and etc. in your refrigerator must be fastened securely by adhesive tape against any jolt before repackageing.
3. Packaging must be tied with thick tapes and strong ropes and the rules of transportation printed on the package must be followed.

#### Please do not forget...

Every recycled material is an indispensable source for the nature and for our national resources.

If you wish to contribute to recycling the packaging materials, you can get further information from the environmental bodies or local authorities.

### Before operating your refrigerator

Before starting to use your refrigerator check the following:

1. Is the interior of the refrigerator dry and can the air circulate freely in the rear of it?
2. Please install the 2 plastic wedges as illustrated in the figure.

Plastic wedges will provide the required distance between your refrigerator and the wall in order to allow the air circulation. (The illustrated figure is only an example and does not match exactly with your product.)

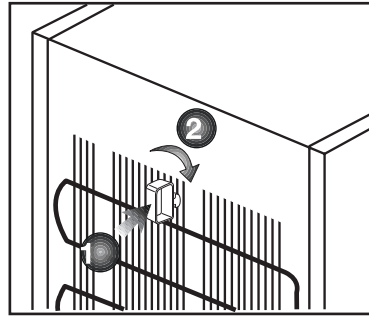

3. Clean the interior of the refrigerator as recommended in the "Maintenance and cleaning" section.
4. Plug the refrigerator into the wall outlet. When the fridge door is open, the fridge compartment interior light will come on.
5. You will hear a noise as the compressor starts up. The liquid and gases sealed within the refrigeration system may also give rise to noise, even if the compressor is not running and this is quite normal.
6. Front edges of the refrigerator may feel warm. This is normal. These areas are designed to be warm to avoid condensation.

## Electric connection

Connect your product to a grounded socket which is being protected by a fuse with the appropriate capacity.

Important:

- The connection must be in compliance with national regulations.
- The power cable plug must be easily accessible after installation.
- The specified voltage must be equal to your mains voltage.
- Extension cables and multiway plugs must not be used for connection.

⚠ A damaged power cable must be replaced by a qualified electrician.

⚠ Product must not be operated before it is repaired! There is danger of electric shock!

## Disposing of the packaging

The packing materials may be dangerous for children. Keep the packing materials out of the reach of children or dispose of them by classifying them in accordance with the waste instructions. Do not dispose of them along with the normal household waste.

The packing of your refrigerator is produced from recyclable materials.

## Disposing of your old refrigerator

Dispose of your old refrigerator without giving any harm to the environment.

- You may consult your authorised dealer or waste collection center of your municipality about the disposal of your refrigerator.

Before disposing of your refrigerator, cut out the electric plug and, if there are any locks on the door, make them inoperable in order to protect children against any danger.

## Placing and Installation

**1.** Install your refrigerator to a place that allows ease of use.

**2.** Keep your refrigerator away from heat sources, humid places and direct sunlight.

**3.** There must be appropriate air ventilation around your refrigerator in order to achieve an efficient operation. If the refrigerator is to be placed in a recess in the wall, there must be at least 5 cm distance with the ceiling and at least 5 cm with the wall. If the floor is covered with a carpet, your product must be elevated 2.5 cm from the floor.

**4.** Place your refrigerator on an even floor surface to prevent jolts.

## Adjusting the feet

If your refrigerator is unbalanced;  
You can lever your refrigerator by turning the front feet as shown in the illustration below. The corner where the feet exists is lowered when you turn it in the direction of black arrow and raised when you turn in the opposite direction. Getting help from someone to slightly lift the refrigerator will facilitate this process.

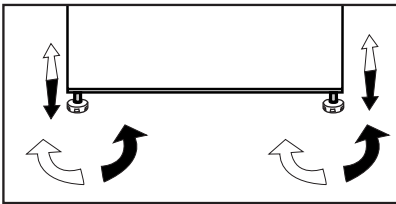

## Changing the illumination lamp

To change the Bulb/LED used for illumination of your refrigerator, call your AuthorisedService.

The lamp(s) used in this appliance is not suitable for household room illumination. The intended purpose of this lamp is to assist the user to place foodstuffs in the refrigerator/freezer in a safe and comfortable way. The lamps used in this appliance have to withstand extreme physical conditions such as temperatures below  $-20^{\circ}\text{C}$ .

(only chest and upright freezer)

This product is equipped with a lighting source of the "G" energy class.

The lighting source in this product shall only be replaced by professional repairers.

# Reversing the doors

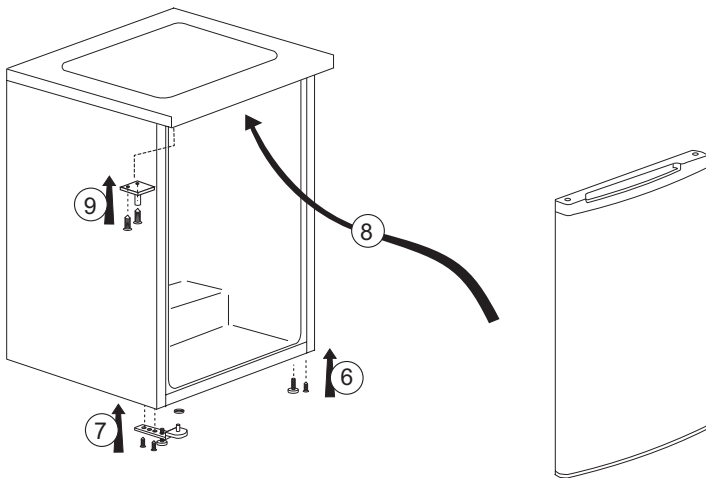
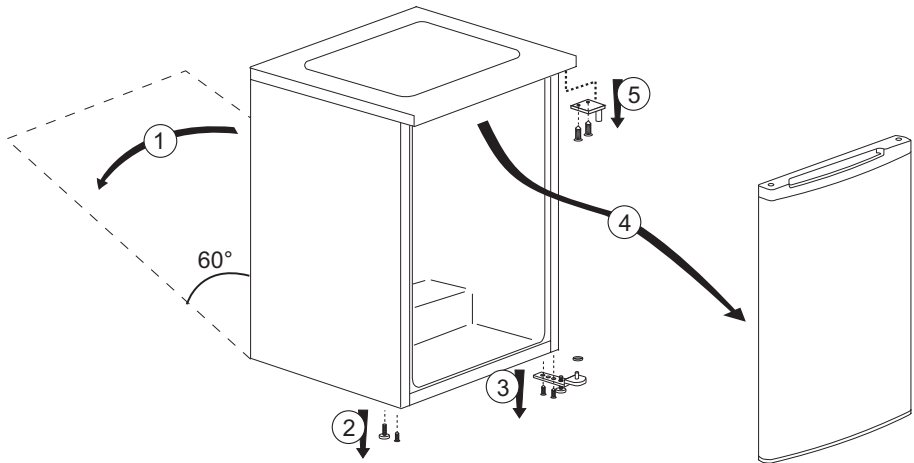

## Reversing the door

Follow the step by step instructions and the diagram below. Numbers in brackets refer to diagrams.

1. Switch off at the socket outlet and pull out the mains plug.
2. Remove all food, loose items and fittings from inside the appliance and door shelves.
3. Carefully tilt the appliance on its back side. (1) (You may need somebody to help you.) Take care not to damage the appliance by laying on some protective material (e.g. its original packaging). Make sure that you tilt the appliance on its back side, do not lay on it's side otherwise compressor oil may block the pipes and you may damage the appliance.
4. Unscrew and remove the LHS front feet and bolt (2).
5. Unscrew the bolts and remove the bottom hinge while holding the door (3).
6. Remove the door carefully from the top hinge by sliding down wards (4).
7. Reposition top hinge bushing and blanking plug on the opposite side and stand the door safely (5). You may find it easier to remove the bushing and the plug with the tip of a small screwdriver. Take care not to mark the door.
8. Reposition the top hinge on the opposite side (6 and 7).

9. To refit the door, locate the top hinge in the door, attach to the cabinet and hold the door (8).

10. Fit the bottom hinge (9). If necessary adjust and then tighten the bolts. Ensure, that the door opens and closes easily and that there are no gaps allowing air into the cabinet. If there are gaps between the door seal and the cabinet, adjust the door seal by gently pulling away from the door using fingers.

11. Fit the other front feet (10).

12. Carefully stand your appliance. (You may need somebody to help you.) Adjust the front feet (See Installation Instructions)

13. Put back all, loose items and fittings.

14. Wait for at least 4 hours to allow the system to settle before switching on.

## 4 Preparation

---

- For a freestanding appliance; 'this refrigerating appliance is not intended to be used as a built-in appliance'.
- Your refrigerator should be installed at least 30 cm away from heat sources such as hobs, ovens, central heater and stoves and at least 5 cm away from electrical ovens and should not be located under direct sunlight.
- The ambient temperature of the room where you install your refrigerator should at least be 5°C.
- Please make sure that the interior of your refrigerator is cleaned thoroughly.
- If two refrigerators are to be installed side by side, there should be at least 2 cm distance between them.
- When you operate your refrigerator for the first time, please observe the following instructions during the initial six hours.
- The door should not be opened frequently.
- It must be operated empty without any food in it.
- Do not unplug your refrigerator. If a power failure occurs out of your control, please see the warnings in the "Recommended solutions for the problems" section.
- Original packaging and foam materials should be kept for future transportations or moving.

## 5 Using your refrigerator

Setting the operating temperature

The operating temperature is regulated by the temperature control.

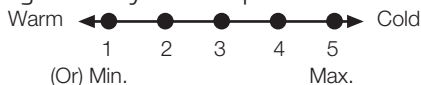

**1 = Lowest cooling setting  
(Warmest setting)**

**5 = Highest cooling setting  
(Coldest setting)**

(Or)

**Min. = Lowest cooling setting**

(Warmest setting)

**Max. = Highest cooling setting**

(Coldest setting)

The average temperature inside the fridge should be around +5°C.

Please choose the setting according to the desired temperature.

You can stop operation of your appliance by turning the thermostat knob to "0" position.

Please note that there will be different temperatures in the cooling area.

The coldest region is immediately above the vegetable compartment.

The interior temperature also depends on ambient temperature, the frequency with which the door is opened and the amount of foods kept inside.

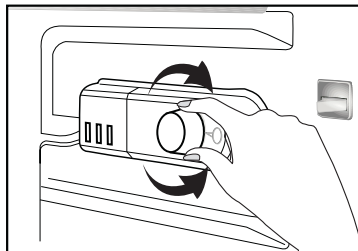

Frequently opening the door causes the interior temperature to rise.

For this reason, it is recommended to close the door again as soon as possible after use.

### Using interior compartments

Movable shelves: Distance between the shelves can be adjusted when necessary.

Vegetable drawer: Vegetables and fruits can be stored in this compartment for long periods without decaying.

Bottle shelf: Bottles, jars and tins can be placed in these shelves.

### Cooling

#### Food storage

The refrigerator is for the short-term storage of fresh food and drinks.

Store milk products in the intended compartment in the refrigerator.

Bottles can be stored in the bottle shelf of the door.

Raw meat is best kept in a polyethylene bag on the bottom shelf (crisper cover)

Allow hot foods and beverages to cool to room temperature prior to placing them in the refrigerator.

## Attention

Store concentrated alcohol only standing upright and tightly closed.

## Attention

Do not store explosive substances or containers with flammable propellant gases (canned cream, spray cans etc.) in the device. There is a danger of explosion.

## Defrosting

The refrigerator defrosts automatically. The thawing water flows through the drain channel into a collection container at the rear of the device.

During defrosting, water droplets form at the back of the fridge due to the evaporator.

If not all of the drops run down, they may freeze again after defrosting remove them with a cloth soaked in warm water, but never with a hard or sharp object.

Check the flow of the thawed water from time to time. It may become plugged occasionally.

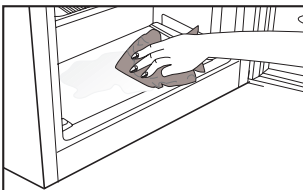
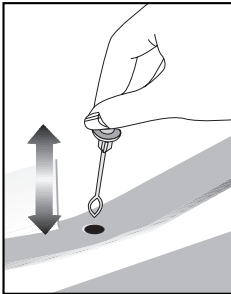

## Stopping your product

If your thermostat is equipped with "0" position:

- Your product will stop operating when you turn the thermostat button to "0" (zero) position. Your product will not start unless to you turn the thermostat button to position "1" or one of the other positions again.

If your thermostat is equipped with "min" position:

- Unplug your product to stop it.



## 6 Maintenance and cleaning

Cleaning your fridge at regular intervals will extend the service life of the product.



### **WARNING:**

Unplug the product before cleaning it.

- Never use gasoline, benzene or similar substances for cleaning purposes.
- Never use any sharp and abrasive tools, soap, household cleaners, detergent and wax polish for cleaning.
- For non-No Frost products, water drops and frosting up to a fingerbreadth occur on the rear wall of the Fridge compartment. Do not clean it; never apply oil or similar agents on it.
- Only use slightly damp microfiber cloths to clean the outer surface of the product. Sponges and other types of cleaning cloths may scratch the surface
- Dissolve one teaspoon of bi-carbonate in half litre of water. Soak a cloth with the solution and wrung it thoroughly. Wipe the interior of the refrigerator with this cloth and the dry thoroughly.
- Make sure that no water enters the lamp housing and other electrical items.
- If you will not use the refrigerator for a long period of time, unplug it, remove all food inside, clean it and leave the door ajar.
- Check regularly that the door gaskets are clean. If not, clean them.
- To remove door and body shelves, remove all of its contents.
- Remove the door shelves by pulling them up. After cleaning, slide them from top to bottom to install.
- Never use cleaning agents or water that contain chlorine to clean the outer surfaces and chromium coated parts of the product. Chlorine causes corrosion on such metal surfaces.

### **6.1 Avoiding bad odours**

- Materials that may cause odour are not used in the production of our refrigerators. However, due to inappropriate food preserving conditions and not cleaning the inner surface of the refrigerator as required can bring forth the problem of odour. Pay attention to following to avoid this problem:
- Keeping the refrigerator clean is important. Food residuals, stains, etc. can cause odour. Therefore, clean the refrigerator with bi-carbonate dissolved in water every few months. Never use detergents or soap.
- Keep the food in closed containers. Microorganisms spreading out from uncovered containers can cause unpleasant odours.
- Never keep the food that have passed best before dates and spoiled in the refrigerator.

### **6.2 Protecting the plastic surfaces**

Do not put liquid oils or oil-cooked meals in your refrigerator in unsealed containers as they damage the plastic surfaces of the refrigerator. If oil is spilled or smeared onto the plastic surfaces, clean and rinse the relevant part of the surface at once with warm water.

## 7 Do's and don'ts

---

Do- Clean your appliance regularly (See "Cleaning and Care")

Do- Keep raw meat and poultry below cooked food and dairy products.

Do-Keep food for as short a time as possible and adhere to 'Best Before' and "Use By" dates.

Do- Take off any unusable leaves on vegetables and wipe off any soil.

Do- Leave lettuce, cabbage, parsley and cauliflower on the stem.

Do- Wrap cheese firstly in greaseproof paper and then in a polythene bag excluding as much air as possible. For best results take out of the fridge compartment an hour before eating.

Do- Wrap raw meat and poultry loosely in polythene or aluminium foil. This prevents drying.

Do- Wrap fish and offal in polythene bags.

Do- Wrap food which have a strong odour or can dry out in polythene bags, aluminium foil or place in an airtight container.

Do- Wrap bread well to keep it fresh.

Do- Chill white wines, beer, lager and mineral water before serving.

Don't- Store bananas in your fridge.

Don't- Store melon in your fridge. It can be chilled for short periods as long as it is wrapped to avoid it flavouring other food.

Don't- Leave the door open for long periods as this will make the larder refrigerator more costly to run.

Don't- Don't- Store poisonous or any dangerous substances in the larder refrigerator. Your larder refrigerator has been designed for the storage of edible foodstuffs only.

Don't- Consume food which has been stored for an excessive time in the larder refrigerator.

Don't- Consume food which has been stored for an excessive time in the larder refrigerator.

Don't- Store cooked and fresh food together in the same container. They should be packaged and stored seperately.

Don't- Let defrosting food or food juices drip onto food in your larder refrigerator.

### Problem Solving

If the appliance does not operate when switched on, check whether:

- The plug is inserted properly in the socket and that the power supply is on. (To check the power supply to the socket, plug in another appliance)
- The fuse has blown/circuit breaker has tripped/main distribution switch has been turned off.
- The temperature control has been set correctly.
- New plug is wired correctly if you have changed the fitted moulded plug.

If the appliance is still not operating after the above checks, please refer to the section on "How To Obtain Service".

Please ensure that above checks have been made as a charge will be made if no fault is found.

Your new Zenith product is guaranteed against faulty materials, defective components or manufacturing defects. The guarantee starts from the date of original purchase of the product for a period of one (1) year, unless Beko plc (the "Manufacturer") agrees to extend the guarantee for the product in writing. If you have any questions about the guarantee on your product (including how long it is valid), please contact your retailer or our Call Centre on 0333 207 2028.

This guarantee does not in any way diminish or affect your statutory rights in connection with the product. This guarantee is in addition to your statutory rights as a consumer. If you have any questions about these rights, please contact the retailer from which you purchased the product. In certain circumstances, it is possible that your statutory rights may offer additional or higher levels of protection than those offered under the terms of this guarantee.

### **What is covered by this guarantee?**

- Repairs to the product required as a result of faulty materials, defective components or manufacturing defects.
- Functional replacement parts to repair a product.
- The costs of a Zenith Approved Engineer to carry out the repair.

### **What is not covered?**

- Transit and delivery damage.
- Cabinet or appearance parts, including but not limited to control knobs, flaps and handles.
- Accessories and/or consumable items including but not limited to ice trays, scrapers, cutlery baskets, filters and light bulbs.
- Repairs necessary as a direct or indirect result of:
  - Accidental damage, misuse or abuse of a product.
  - An attempted repair of a product by anyone other than a Zenith Approved Engineer (the "Engineer").
  - Installation or use of a product where such installation or use fails to meet the requirements contained in this guarantee or the product manual.
- Repairs to a product operated at any time on commercial or non-residential household premises (unless we have previously agreed to the installation environment).

This guarantee is limited to the cost of repairing the product. To the extent permitted by law, Beko plc (the "Manufacturer") does not accept and will not be held liable for any financial loss incurred in connection with the failure of any product to operate in accordance with the expected standards. Such financial loss includes but is not limited to loss arising from:

- Time taken off work.
- Damaged food, clothing or other items.
- Meals taken at restaurants or from takeaways.

- General compensation for inconvenience. Important Notes
- Your product is designed and built for domestic household use only.
- The guarantee will automatically be void if the product is installed or is used in commercial or non-residential domestic household premises, unless we have previously agreed to the installation environment.
  - The product must be correctly installed, located and operated in accordance with the instructions contained in the product manual provided with your product.
  - Professional installation by a qualified electrical domestic appliance installer is recommended for all washing machines, dishwashers and electric cookers (as incorrect installation may result in you having to pay for the cost of repairing the product).
  - Gas Cookers must be professionally installed by a Gas Safe (or Gas Networks Ireland for Republic of Ireland) registered gas installer.
  - This guarantee is given in respect of products purchased and used within the United Kingdom.
  - This guarantee is effective from the initial date of purchase of a new product from an authorised retailer and will be void if the product is resold.
  - This guarantee does not apply to graded sales (where the product is purchased as a second").
  - Possession of a copy of these terms and conditions does not necessarily mean that a product has the benefit of this guarantee. If you have any questions, please call our Call Centre on the number set out above.
  - The Manufacturer reserves the right to terminate the guarantee if its staff or representatives are subjected to physical or verbal abuse in the course of carrying out their duties.
  - Optional extras, where available (i.e. extendable feet) are supplied on a chargeable basis only.

### **Does Zenith offer replacements?**

This is a repair-only guarantee. On occasion the Manufacturer may at its sole discretion, replace your product with a new product instead of carrying out a repair. Where a replacement is offered, this would normally be an identical model, but when this is not possible, a model of similar specification will be provided. The Manufacturer will cover the costs and arrange for the delivery of the new product and for the return of the old product. Any costs related to disconnecting the faulty product and installing the replacement product will not be borne by the Manufacturer unless previously agreed to in writing. The original guarantee will continue to apply to the replacement product; the new product will not come with a new guarantee.

## **When will the repair take place?**

Our engineers work Monday to Friday 9.00am to 5.00pm. Appointments outside these hours may be possible at the sole discretion of the Manufacturer but cannot be guaranteed. Whilst our Engineers will endeavour to minimize inconvenience and to meet requests for specific timed appointments, this cannot be guaranteed. The Manufacturer will not be liable for delays or if it is unable to carry out a repair because a convenient appointment cannot be arranged.

## **Will there be any charge for the repairs?**

It is your responsibility to provide evidence to the Engineer that your product is covered by this guarantee with a proof of purchase. The Manufacturer reserves the right to charge for the reasonable cost of any service call if:

- You cannot provide evidence that your product is covered by this guarantee.
- Where a service call has been made and the engineer finds that there is no fault with your product.
- That your product has not been installed or operated in accordance with the User

Instructions Booklet.

- That the fault was caused by something other than faulty materials, defective components or manufacturing defects.
- For missed appointments.

Payment of these costs are due immediately upon the Engineer providing you with an invoice. If you fail to pay the costs for the service call in a timely manner, the Manufacturer reserves the right to terminate the guarantee.

If you are a resident of the United Kingdom, this guarantee will be governed by English law and subject to the English Courts, save where you live in another part of the United Kingdom, in which case the law and courts of that location will apply.

## **HOW TO OBTAIN SERVICE**

Please keep your purchase receipt or other proof of purchase in a safe place; you will need to have it should the product require attention under guarantee.

It will be useful if you complete the details below, as it will help us assist you when requesting service. (The model number is printed on the Instruction Booklet and the serial number is printed on the Rating Label affixed to the appliance). Recording of these details alone will not count as proof of purchase. A valid proof of purchase is required for under guarantee service.

## **The area around the product must be easily accessible to the Engineer without the need for cabinets or furniture being removed.**

It is your responsibility to ensure our Engineers have a clean and safe environment to carry out any repairs.

**Model No:**

**Serial No: Retailer:**

**Date of purchase:**

For service under guarantee simply telephone the appropriate number below

**UK Mainland & Northern Ireland: 0333 207 2028.**

**Register your appliance at** <https://www.zenithappliance.co.uk>

Before requesting service please check the troubleshooting guide in the Operating Instructions as a charge may be levied where no fault is found even though your product may still be under guarantee.

**Service once the manufacturer's guarantee has expired.**

If you have purchased an extended guarantee please refer to the instructions contained within the extended guarantee agreement document, otherwise please call the appropriate number above where service can be obtained at a charge.

Should you experience any difficulty in obtaining service contact the Zenith Customer Helpline on Tel: 0333 207 2028 or email:

**[customerservice@support.zenithappliance.co.uk](mailto:customerservice@support.zenithappliance.co.uk)**

This guarantee is provided by Beko plc. Beko House, 1 Greenhill Crescent, Watford, Herts, WD18 8QU. Beko plc is registered in England and Wales with company registration number 02415578.

