

INSTRUCTIONS FOR USE TUMBLE DRYER

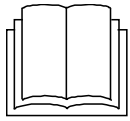

White Knight



IMPORTANT: PLEASE READ THESE INSTRUCTIONS THOROUGHLY BEFORE USING THIS APPLIANCE. KEEP THEM IN A SAFE PLACE FOR FUTURE REFERENCE.

IMPORTANT USER INFORMATION

These notes are provided in the interest of safety. You must read them before installing or using the appliance.

- This tumble dryer is intended for **NORMAL DOMESTIC USE ONLY**.
- This appliance can be used by children aged from 8 years and above and persons with reduced physical, sensory or mental capabilities or lack of experience and knowledge if they have been given supervision or instruction concerning use of the appliance in a safe way and understand the hazards involved. Children shall not play with the appliance. Cleaning and user maintenance shall not be made by children without supervision. Children of less than 3 years should be kept away unless continuously supervised.
- Adequate ventilation must be provided to avoid back flow of gases into the room from appliances burning other fuels, including open fires.

- Exhaust air must not be discharged into a flue which is used for exhausting fumes from appliances burning gas or other fuel.
- Please note it is not recommended that the dryer is placed directly next to ovens or cookers as the performance of the dryer may be affected.
- The tumble dryer is not to be used if industrial chemicals have been used for cleaning.
- The appliance must not be installed behind a lockable door, a sliding door or a door with a hinge on the opposite side to that of the tumble dryer, in such a way that a full opening of the tumble dryer door is restricted.
- A carpet must not obstruct the ventilation openings in the base of the dryer.
- Do not stack the tumble dryer on top of other appliances without the correct stacking kit.
- Any electrical work required to install the appliance should be carried out by a qualified person.
- It is important to clean the lint filter after each drying cycle or the restrictions to airflow will extend drying times and could cause the safety cut-out to trip.
- Under no circumstances should anything other than the recommended articles be placed in the tumble dryer.
- The tumble dryer should be serviced by an appointed service organisation and only genuine parts used.
- It is dangerous to alter or modify the product in any way other than fitting authorized accessories.
- We recommend that the appliance is unplugged each time after use. It should always be disconnected from the electricity

supply for long periods (i.e. weekends, if it is to be left unattended for holidays etc.)

- The rear of the dryer gets quite hot during use. Position the dryer so that the back is not accessible while in operation, but ensure that the sides have a space available to allow airflow.
- The special mains cable and plug assembly must only be replaced with a genuine part by the manufacturer or his service agents in order to avoid a hazard.
- It is important to clean fluff from the window of the dryer and around the door seal after each drying cycle. Failure to do so could result in water leaking.

WARNING: If you need to stop the tumble dryer before the end of a drying cycle, ensure that the load and appliance are cooled by utilizing the cooldown period denoted on the control panel. Once the load is removed, all items need to be quickly spread out so that any residual heat is dissipated.

Remove all objects from pockets such as lighters and matches.

DO NOT use a two-way adaptor, or extension lead. The dryer must be connected to its own socket.

DO NOT block the air inlets at the base and side of your dryer.

DO NOT allow fluff to accumulate around the tumble dryer.

Risk of fire

DO NOT exceed the recommended maximum load.

DO NOT dry unwashed items in the tumble dryer

DO NOT place articles in the dryer if anything other than a water solution has been used in the cleaning process.

DO NOT attempt to dry dripping wet articles.

DO NOT use the tumble dryer if you suspect that it is damaged in any way. Under no circumstances should you attempt to repair the appliance yourself. Repairs carried out by inexperienced persons may cause serious injury. Consult your local appointed service engineer and insist on genuine spare parts.

WARNING: The appliance must not be supplied through an external switching device, such as a timer, or connected to a circuit that is regularly switched on and off by a utility.

NOT SUITABLE FOR USE WITH CONDENSING BOXES.

ADDITIONAL INFORMATION

Many outlets sell “universal” tumble dryer accessories. These may not fit satisfactorily and could impair the efficient operation of your tumble dryer and may even cause air-flow restrictions not covered by our guarantee. Crosslee always obtains test house approval for dryer accessories so use this order form to obtain genuine authentic accessories.

INSTALLATION

Position the tumble dryer so that the plug remains accessible after installation. Ensure that the mains cable of the appliance is not trapped between the appliance and any surface behind the appliance.

Do not block the vent at the side or base of the dryer, as this will impair the working of the machine.

TUMBLE DRYER VENTING

Your tumble dryer may be supplied with a vent hose (If not, one is available as an accessory).

A vent hose allows you to direct the warm, damp air expelled from the rear of the dryer to an open door or window.

The best solution is to make a permanent connection through either a wall or a window. This is particularly recommended for small, cool rooms and a kit for this purpose is available as an accessory.

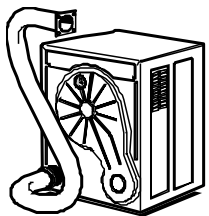

When using a vent hose, remember the following points:

The vent hose must be at least 10cm (4 ins) in diameter.

No more than three right-angled bends should be allowed when positioning the vent hose.

Do not distort or constrict the vent hose as this will reduce the airflow.

When drying, the vent hose must always be extended to an open door or window.

The vent hose must not be shared with other appliances, for example, a cooker hood outlet.

Note: Do not obstruct or add a mesh to the vent hose outlet during use and ensure that it cannot be blocked or bent sharply which may obstruct the airflow.

It is recommended that the interior of the hose be periodically inspected and cleaned if necessary.

FINAL INSTALLATION

Push the filter into its operating position as shown in the diagram. Remove any dust by wiping the drum and door with a damp cloth. Any initial smell of burning will be caused by dust on the heater and will quickly disappear.

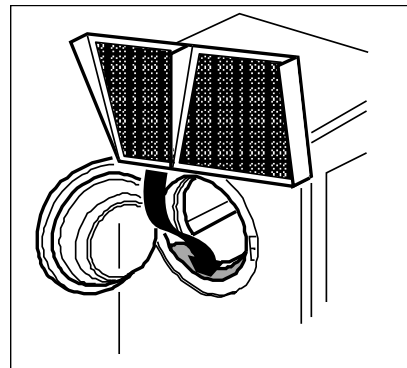

THE CONTROLS

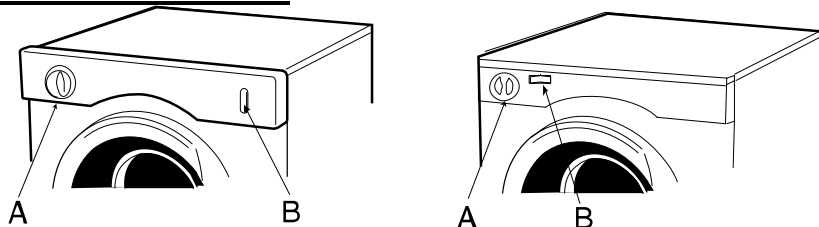





A. THE TIMER Turn the timer knob clockwise to select the required drying time based on the recommendations on the control panel.

B. HEAT SWITCH Select the required heat setting based on the recommendations on the control panel.

PREPARATION

Check care labels inside the garments.

CARE LABELS YOU MAY FIND ON YOUR FABRICS

	Suitable for tumble drying
	Tumble dry using full heat
	Tumble dry using half heat
	Do not tumble dry

Do not tumble dry woollen or wool mixture articles unless the article is labelled as being suitable. This should avoid shrinkage.

Place delicate articles, e.g. tights, scarves, inside a pillowcase.

To avoid the need to iron easycare polyester/cotton items it is better to only dry small loads (i.e. half fill drum) It is better to dry small and large articles together.

Fabric softeners, or similar products, should be used as specified by the fabric softener instructions.

Do not overload the dryer or dry large bulky items such as duvets or sleeping bags as it is important that the airflow through the dryer is not obstructed.

The final part of a tumble dryer cycle occurs without heat (cool down cycle) to ensure that the items are left at a temperature that ensures that the items will not be damaged.

Items that have been soiled with substances such as cooking oil, acetone, alcohol, petrol, kerosene, spot removers, turpentine, waxes and wax removers should be washed in hot water with an extra amount of detergent before being dried in the tumble dryer.

Items such as foam rubber (latex foam), shower caps, waterproof textiles, rubber backed articles and clothes or pillows fitted with foam rubber pads should not be dried in the tumble dryer.

OPERATION

Open the door.

Load clothes loosely into the drum.

Load sheets first, starting with one corner.

Close the door.

Dry your hands.

Check that the timer is in the '0' position.

Plug in the machine.

Select correct heat position, (see programme chart on control panel for recommendations).

The standard cotton programme is suitable to dry normal wet cotton laundry. It is the most efficient programme in terms of energy consumption for drying wet cotton laundry.

Your appliance is a reversing type, a full load will typically take 127 minutes and will use approximately 2.56kWh of electricity. A half load will typically take 66 minutes and will use approximately 1.19 kWh of electricity.

The power consumption of the off-mode and the left-on mode is zero.

Turn the timer knob clockwise to select the required drying time (see programme chart on control panel for recommendations).

For energy labeling purposes (EN61121:2005) for a cotton dry load, use the maximum load weight for cotton and set the timer to the recommended drying time for cotton dry as specified on the control panel.

The drum will begin rotating. Reversing drum models will stop periodically to rotate in the reverse direction for a short time.

Should the clothes become dry before the cycle has finished, or if an excessive programme time has been selected, the drum will continue to rotate while the thermostat will automatically switch the heater off to reduce the risk of over drying and save energy.

If the door is opened during a cycle the dryer will stop. To restart your machine, close the door. When drying large items such as sheets, we suggest you periodically stop the dryer to redistribute the load, and restart it immediately afterwards.

To lengthen or shorten a timed programme, reset the timer knob.

There is an automatic 12 minute cool down period at the end of every cycle, during which the heater is switched off. This helps to minimize creasing, and must always be used fully to avoid the risk of fire.

NEVER SWITCH THE DRYER OFF AND LEAVE A HOT LOAD IN THE DRUM. RISK OF FIRE.

ALWAYS CLEAN THE FILTER AFTER EACH USE. Failure to do so could cause the safety cut-out to operate.

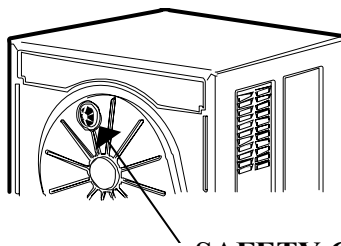
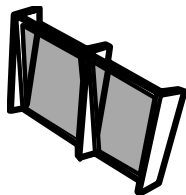

SAFETY CUT-OUT

- Pull the filter upwards and away from the appliance.
- Remove any threads or fluff by hand or with a soft brush.
- Slide the filter back.
- Wash the filter occasionally in detergent solution using a soft brush to remove small particles.
- If your filter becomes damaged, replace it to ensure no damage is caused to the dryer.

TECHNICAL DATA OVERALL DIMENSIONS:

Height: 67 cm
Width: 50 cm
Depth: 47 cm

MAXIMUM DRY WEIGHT LOADS:

Cotton 3.5kg
'Easycare' polyester/cotton 3.5kg
(For minimum creasing 1.5kg)
Delicates 3.5kg

For electrical ratings see plate on back of dryer.

For Model No. see serial plate inside door (needed when requesting service).

Room temperature range 5°C to 30°C. (Drying performance decreases as room temperature falls).

Your washing machine should have a spin speed of not less than 1000rpm for maximum efficiency.

THIS APPLIANCE MUST BE EARTHED

798 Wall / Window Vent Kit

Note: To make a remote connection e.g. more than 30cm (12ins.) from the dryer you will require the vent hose CL001. S.

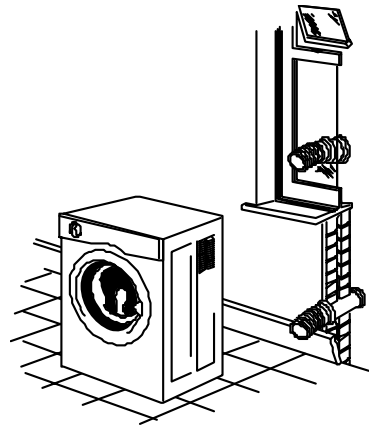

This appliance is marked according to the European Directive 2012/19/EU on Waste Electrical and Electronic Equipment (WEEE).

This guideline is the frame of a European wide validity of return and recycling on Waste Electrical and Electronic Equipment.

VENT HOSE ASSEMBLY

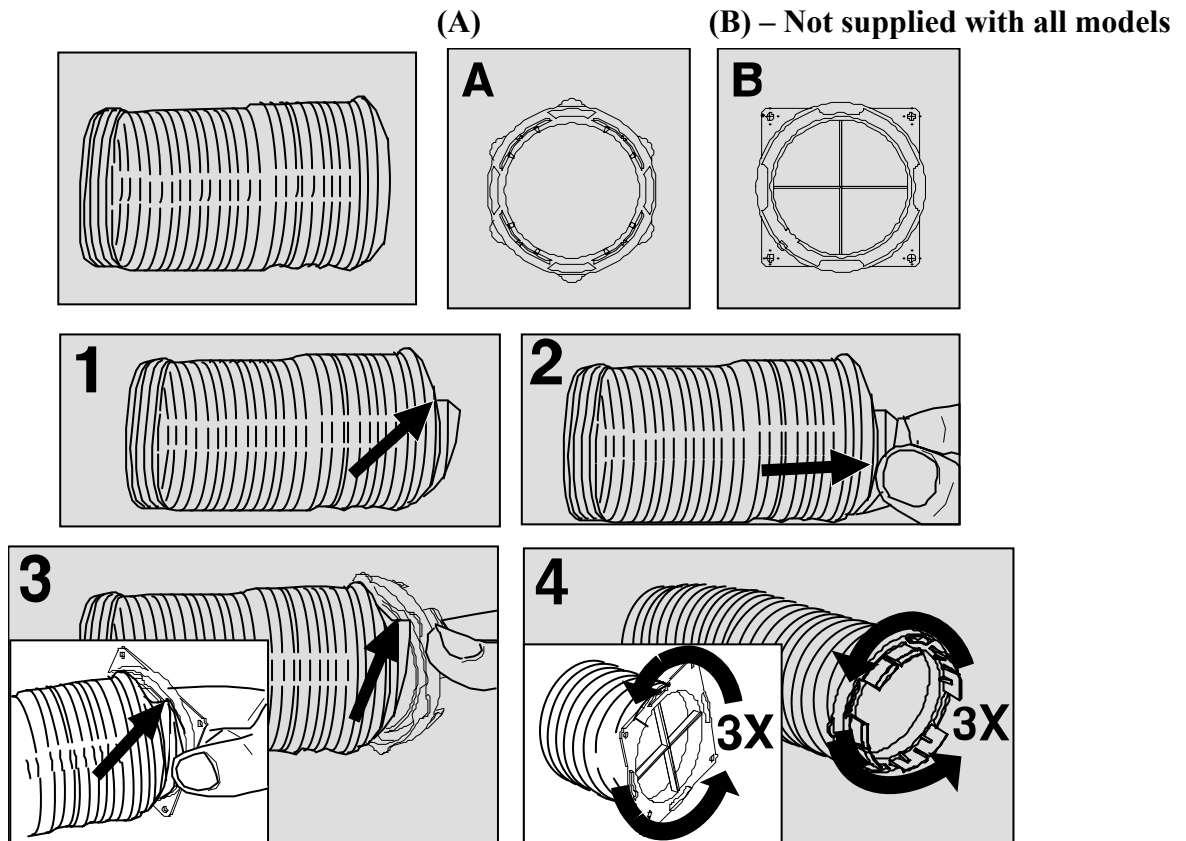

One end of the vent hose is fitted with an adaptor (A) which can be pushed into the exhaust outlet at the bottom rear of the tumble dryer. The free end should be led to a suitable outlet. It may simply be hung through an open window or a more permanent connection made using the four holes in the hose adaptor flange. (B), if supplied.

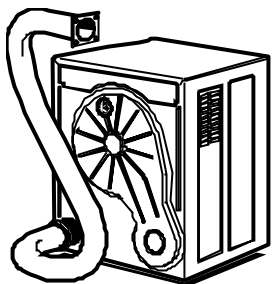

Note: Do not obstruct or add a mesh to the vent hose outlet during use and ensure that it cannot be blocked or bent sharply which may obstruct the air flow. It is recommended that the interior of the hose be periodically inspected and cleaned if necessary.

CUSTOMER ADVICE – BEFORE CALLING FOR ASSISTANCE

If the clothes are not dry after normal drying time:

- Check that you used the correct heat setting.
- Check that you have not set the timer within a cool down period.
- Check that the lint filter has been cleaned. A blocked filter will restrict the airflow.
- Check that your dryer is heating - below the door to the left side, should feel warm to the touch after the first 10-15 minutes of its programme.

Failure to heat may indicate the safety cut-out has operated. To reset, simply press the red button at the rear of the machine. If it has operated then a sharp “click” will be heard.

This cut-out only operates if the airflow is severely restricted so make sure the filter is clean, the air inlets and outlets at the side and back are not blocked, and that all other restrictions are removed before re-starting.

If the cut-out continues to operate after checking the above points, you should contact your service agent.

Check that the machine has the correct weight load in the drum before starting the appliance.

If your machine does not work check the following before calling a service engineer:-

- Check that there is a supply of electricity.
- Check that the door has been properly closed and the machine is switched on.
- Check the fuse in the moulded plug.

A call out charge will be applied for a service visit, if the call could have been avoided by following these instructions.

ESSENTIAL CONTACT INFORMATION FOR “IN GUARANTEE” AND “OUT OF GUARANTEE” REPAIRS.

If problems continue after checking the above points you should **contact our service agent**. Please ensure that you have your serial number and model number to hand when you make the call. To locate the serial number on your dryer, open the door and look for a white label inside the door opening. This will indicate the appliance model number along with the serial number.

APPROVED SERVICE AGENTS: UK (Great Britain & Northern Ireland)

Call White Knight **ON** 0800 988 1323 (calls are free from landlines however calls from mobiles may be charged at your network provider’s rates) **OR** 0344 8797422 (Calls charged at basic rate).

APPROVED SERVICE AGENTS: REPUBLIC OF IRELAND

Call White Knight **ON** 0044 800988 1323 **OR** 0044 344 8797422 (for call charges please check with your telecoms provider).

	Compact SDO Rev
Suppliers name or trade mark	WHITE KNIGHT
Model identifier	C38AW/C39AW/C39AS
Rated capacity at full load	3.5kg
Appliance type	Air Vented
Energy efficiency class	C
Energy consumption of the appliance*	284kWh
<p>The figures above is based on 160 drying cycles of the standard cotton programme at full and partial load and the consumption of the low-power modes. Actual energy consumption per cycle will depend on how the appliance is used.</p>	
Automatic/non-automatic	Non-automatic
EU Ecolabel	N/A
E_{dry}	2.56kWh
$E_{dry\frac{1}{2}}$	1.19kWh
$E_{g_{dry}}$	N/A
$E_{g_{dry\frac{1}{2}}}$	N/A
$E_{g_{dry,a}}$	N/A
$E_{g_{dry\frac{1}{2},a}}$	N/A
Off mode power (P_o)	0W
Left on mode power (P_l)	0W
Duration of left-on mode	N/A
<p>The standard cotton programme used at full and partial load is the standard drying programme to which the information in the label and the fiche relates. This programme is suitable for drying normal wet cotton laundry. It is the most efficient programme in terms of energy consumption for cotton.</p>	
T_t	92mins
T_{dry}	127mins
$T_{dry\frac{1}{2}}$	66mins
Condensing efficiency class	N/A
C_t	N/A
C_{dry}	N/A
$C_{dry\frac{1}{2}}$	N/A
Sound power level	64dBA
Built in/not built in	This appliance is not intended to be built in.

