

Wireless Speaker  
SRS-XB23

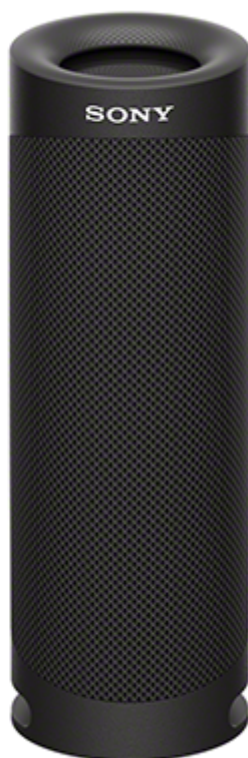

The following explains how to use this speaker. Select a topic from the navigation pane.  
Design and specifications are subject to change without notice.

## Getting started

### [Parts and controls](#)

#### Included items

- [Using the strap](#)

#### Power source/charging

- [Charging the speaker](#)
- [Turning the power on](#)
- [Turning the power off](#)
- [Using the BLUETOOTH standby function](#)
- [Auto power off \(Auto Standby\) function](#)

## Making connections

### BLUETOOTH

- [Pairing and connecting with BLUETOOTH® devices](#)
- [Connecting with a computer via a BLUETOOTH connection \(Windows\)](#)
- [Connecting with a computer via a BLUETOOTH connection \(Mac\)](#)

## Listening to music

### BLUETOOTH device

- [Listening to music of a device via BLUETOOTH connection](#)
- [Switching between monaural audio playback and stereo audio playback](#)
- [Selecting the BLUETOOTH audio streaming playback quality \(Codec\)](#)
- [Terminating the BLUETOOTH connection \(After use\)](#)
- [Switching the BLUETOOTH devices connected at the same time \(Multi-device-connection\)](#)

### Stereo Pair function

- [Listening to music wirelessly with 2 speakers \(Stereo Pair function\)](#)
- [Terminating the Stereo Pair function](#)

### Party Connect function

- [Enjoying wireless playback using multiple speakers \(Party Connect function\)](#)
- [Terminating the Party Connect function](#)

### [Enjoying switching the sound effects](#)

## Phone calls

### [Receiving a call](#)

### [Making a call](#)

## Using “Sony | Music Center”

### [What you can do with “Sony | Music Center”](#)

### [Installing “Sony | Music Center”](#)

## Using the voice assist function

### [Using the voice assist function \(Google app\)](#)

### [Using the voice assist function \(Siri\)](#)

## Information

### [About the indicators](#)

### [Updating the pre-installed software](#)

## Notes on use

- [Precautions](#)
- [Notes on charging](#)
- [Notes on waterproof and dust proof features](#)
- [How to care for the speaker](#)
- [About the BLUETOOTH wireless technology.](#)
- [License notice](#)
- [Trademarks](#)

## Troubleshooting

### [What can I do to solve a problem?](#)

#### Power supply

- [Unable to charge the speaker](#)
- [Unable to turn on the speaker or the speaker suddenly turns off](#)

#### Sound

- [No sound/Sound from only one speaker/Low sound level/Distorted sound/Humming or noise in the speaker output/No voice or low voice from callers](#)
- [Sound becomes low while in use](#)

#### BLUETOOTH

- [Unable to pair the speaker with a BLUETOOTH device](#)
- [Unable to connect a BLUETOOTH device with the speaker in the Stereo Pair function](#)
- [Unable to connect with a speaker in the Party Connect function](#)

#### Reset

- [Restarting the speaker](#)
- [Initializing the speaker](#)

## Parts and controls

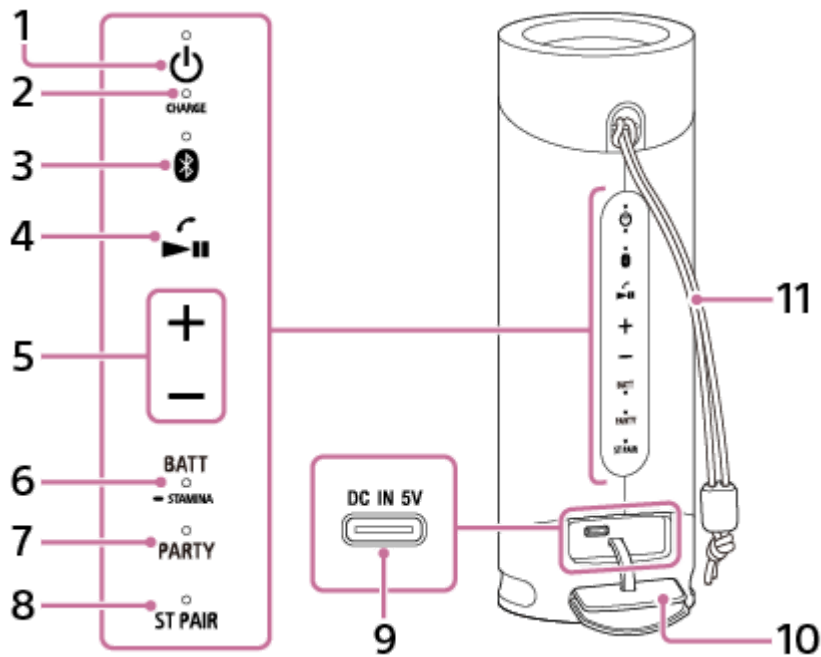

1. (power) button with indicator
2. CHARGE indicator
3. (BLUETOOTH) button with indicator
4. (play) button/ (call) button
5. +/- (volume) buttons
6. BATT (battery) button/ STAMINA button with indicator  
Press the button briefly to hear the voice guidance associated with the remaining battery power. To switch the sound effect between EXTRA BASS mode and STAMINA mode, press and hold the button.

7. PARTY (Party Connect) button with indicator

8. ST PAIR (Stereo Pair) button with indicator

9. DC IN 5V port (USB Type-C®)\*

The built-in battery of the speaker can be charged when connected to an AC outlet via the supplied USB Type-C® cable and a USB AC adaptor (commercially available).

10. Cap

11. Strap

12. Microphone

\* This port is not compatible with music playback.

---

---

### Related Topic

- [About the indicators](#)

## Using the strap

By using the strap attached to the speaker, you can hang and use the speaker even when you have no space to place it.

### 1 Wrap the strap around the desired object.

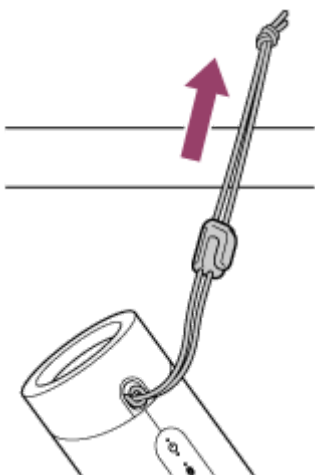

### 2 Put the strap through the clamp and secure the strap end.

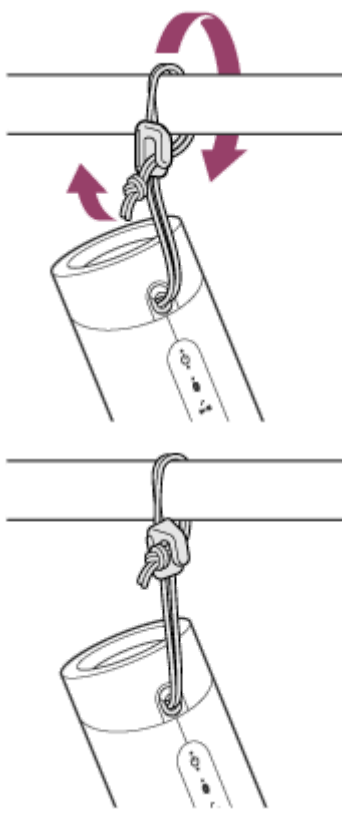

#### Note

- Do not use any strap other than the supplied one.
- After you apply the strap, make sure that the strap end is secured by the clamp.

- Do not pull hard on the strap attached to the speaker or swing the speaker around.
- Do not use the supplied strap with anything other than the speaker.

5-011-826-11(2) Copyright 2020 Sony Corporation

## Charging the speaker

The speaker is capable of running on power either from an AC outlet connected by a USB AC adaptor (commercially available) or from the rechargeable built-in lithium-ion battery.

When using the speaker for the first time, be sure to charge the built-in battery for more than 1 hour before turning on the speaker.

With the built-in battery charged in advance, you can use the speaker solely with battery power.

### 1 Connect the speaker to an AC outlet to charge it.

Connect one end of the supplied USB Type-C® cable to the DC IN 5V port on the speaker and the other end to a USB AC adaptor (commercially available), and then connect the USB AC adaptor to an AC outlet.

The speaker supports USB AC adaptors that are capable of delivering an output current of 1.5 A. Use of any other devices is not guaranteed for battery charging.

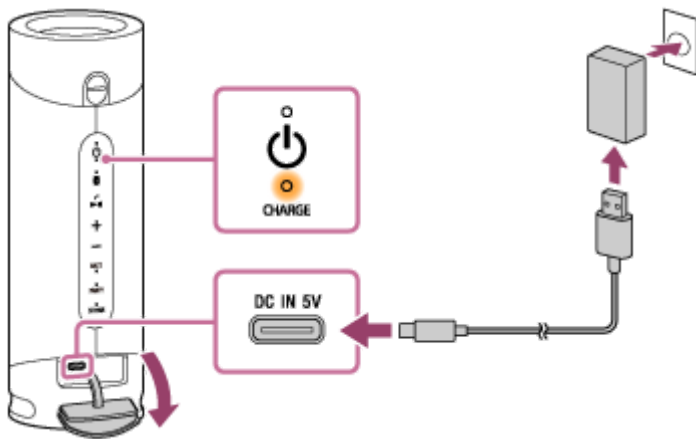

The CHARGE indicator lights up in orange while charging is in progress.

The estimated charging time varies depending on the power output capacity of the connected USB AC adaptor (commercially available). In addition, it may take longer than the charging time stated below depending on the type and specification of the USB AC adaptor and USB cable. The charging time may differ from the time stated below depending on the ambient temperature or the usage of the speaker as well.

The following time is stated as a reference.

- When the recommended USB AC adaptor capable of delivering an output current of 1.5 A is connected, charging completes in about 4 hours\* and the CHARGE indicator turns off.
- When using a commercially available USB AC adaptor, make sure that it is capable of delivering an output current of 1.5 A or more. You can use a USB AC adaptor with an output current of 500 mA or more and less than 1.5 A as well, but it may take a very long time (10 hours or more\*) before charging completes. When using such a USB AC adaptor, it is recommended that you turn off the speaker before battery charging. Use of a USB AC adaptor with an output current of less than 500 mA is not guaranteed for battery charging.

\* Time that is required to charge the empty built-in battery to its full capacity when the speaker turns off.

After you disconnect the USB cable from the speaker upon completion of battery charging, be sure to close the cap securely.

The cap plays a very important role in maintenance of the waterproof and dust proof performance.

## Checking the charging completion



If the built-in battery is fully charged when you connect the speaker to an AC outlet, the CHARGE indicator lights up in orange then turns off after about 1 minute.

## Checking the built-in battery level of the rechargeable built-in battery

- After pressing the BATT (battery) button behind the cap on the rear side of the speaker, when the speaker is turned on, the voice guidance listed below is output from the speaker depending on the remaining built-in battery power.  
80% or more: "Battery fully charged"  
60% or more: "Battery about 70%"  
40% or more: "Battery about 50%"  
20% or more: "Battery about 30%"  
Less than 20%: "Please charge"

### Hint

- By using "Sony | Music Center," you can activate/deactivate the voice guidance associated with the remaining battery power that you hear when you turn on the speaker.
- When using the Android smartphone with OS 8.1 or later installed  
When the speaker is connected with the Android smartphone via an HFP (Hands-free Profile) BLUETOOTH connection, tap [Settings] - [Device connection] - [Bluetooth] on the smartphone. The remaining battery power of the speaker is displayed along with the connected BLUETOOTH device name. For details, refer to the operating instructions supplied with the Android smartphone.  
Note that the remaining battery power displayed on the smartphone may vary from the actual remaining battery power of the speaker. Consider this information as a reference.
- When using the iPhone/iPod touch with iOS 10.0 or later installed  
While the speaker is connected with the iPhone/iPod touch via an HFP (Hands-free Profile) BLUETOOTH connection, the remaining battery power of the speaker is displayed on the widget screen of the iPhone/iPod touch. For details, refer to the operating instructions supplied with the iPhone/iPod touch.  
Note that the remaining battery power displayed on the iPhone/iPod touch may vary from the actual remaining battery power of the speaker. Consider this information as a reference.

## Built-in battery life (using a BLUETOOTH connection)

- About 12 hours  
The volume level of the speaker is set to 34.  
The sound effect is set to STAMINA.
- About 10 hours  
The volume level of the speaker is set to 31.  
The sound effect is set to EXTRA BASS. (factory default settings)
- About 3 hours  
The volume level of the speaker is set to maximum (50).  
The sound effect is set to EXTRA BASS. (factory default settings)

The built-in battery life above is measured using our specified music source.

Actual performance time may vary from the listed time due to the volume, songs played, surrounding temperature, and usage conditions.

## When the built-in battery is running low

When the voice guidance says "Please charge" and the CHARGE indicator flashes slowly, the built-in battery is running low and needs to be charged. In this state, the speaker cannot supply power to other devices.

### Hint

- You can charge the speaker's built-in battery by connecting the USB cable connected with the speaker to a computer that comes equipped with a USB charging port as well. However, not all the computers are tested and found compatible with this procedure and the procedure is not applicable to home-built computers.

- As long as the speaker is connected to an AC outlet by a USB AC adaptor (commercially available) or to a computer that comes equipped with a USB charging port, the speaker's built-in battery is capable of charging itself even while music playback from the speaker is in progress. However, it may take a long time before charging completes depending on the usage of the speaker. It is recommended that you turn off the speaker before battery charging.

### Note

- Depending on the type or specifications of the USB AC adaptor, if you use the speaker at a loud volume, the remaining power of the rechargeable built-in battery may decrease or the speaker may turn off even while the speaker is connected to an AC outlet by the USB AC adaptor. This, however, does not indicate a malfunction. If such a case occurs, turn off the speaker and let the battery fully charge itself before you use the speaker.
- When you use the speaker at a loud volume for a long time, the built-in battery may run low even if the speaker is connected to an AC outlet. As a result, sound becomes low. This is not a malfunction. Turn off the speaker and charge the built-in battery sufficiently.
- The maximum power output will be lower when the built-in battery is running low.
- In an extremely cold or hot environment, charging stops for safety. If charging takes a long time, it also makes charging of the speaker stop. To resolve these issues, disconnect the USB cable, and then connect it again within an operating temperature between 5 °C and 35 °C (41 °F and 95 °F).
- Do not charge the speaker's built-in battery in places where water may splash on it. The supplied USB Type-C® cable as well as the USB port behind the cap are designed neither for waterproof nor for dust proof.
- Even if you do not intend to use the speaker for a long time, charge the built-in battery sufficiently once every 6 months to maintain its performance.
- The multi-device connection is not compatible with HFP (Hands-free Profile). Therefore, when using the multi-device connection, the remaining battery power of the speaker is not displayed on the Android smartphone or the iPhone/iPod touch.
- When the Android smartphone is configured to use only A2DP (Advanced Audio Distribution Profile) for establishing BLUETOOTH connections, the remaining battery power of the speaker is not displayed on the smartphone.

---

---

### Related Topic

- [Turning the power on](#)
- [Notes on charging](#)
- [What you can do with "Sony | Music Center"](#)

## Turning the power on

### 1 Press the (power) button.

The  (power) indicator lights up in green and the  (BLUETOOTH) indicator flashes slowly in blue.

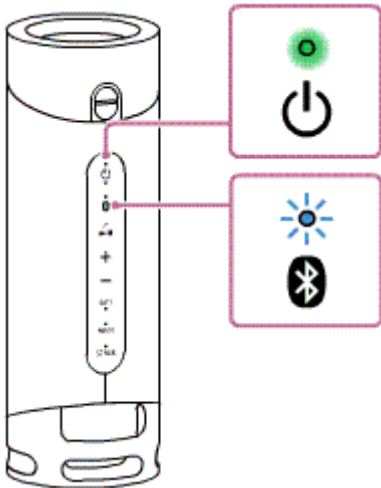

When the speaker has no pairing information, for example when you use the BLUETOOTH function for the first time after purchase, the  (BLUETOOTH) indicator keeps double flashing in blue.



### Hint

- While the voice guidance associated with the remaining battery power is activated, you hear the voice guidance in accordance with the remaining battery power when you turn on the speaker.

### Note

- If the CHARGE indicator flashes 3 times and the speaker turns off after you turn it on, the rechargeable built-in battery is empty. Charge the built-in battery.
- When the CHARGE indicator flashes slowly, the built-in battery is running low and needs to be charged.

### Related Topic

- [Turning the power off](#)
- [Charging the speaker](#)

## Turning the power off

### 1 Press the (power) button.

The  (power) indicator and  (BLUETOOTH) indicator turn off.

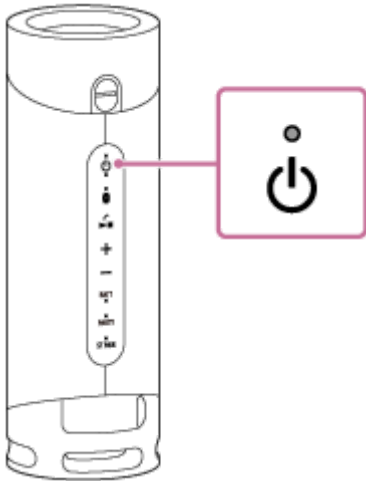

### Hint

- If you turn off the speaker while it is connected to an AC outlet by a USB AC adaptor (commercially available) and the BLUETOOTH standby function is activated, the  (power) indicator will light up in orange and the speaker will enter BLUETOOTH standby mode\*.

\* At the time of purchase, the BLUETOOTH standby function is set to off.

### Related Topic

- [Auto power off \(Auto Standby\) function](#)
- [Using the BLUETOOTH standby function](#)

Wireless Speaker  
SRS-XB23

## Using the BLUETOOTH standby function

When the BLUETOOTH standby function is turned on, the speaker turns on automatically by operating a BLUETOOTH device, and starts the BLUETOOTH connection.

Before operating the speaker, note the following:

- The BLUETOOTH standby function is activated only while the speaker is connected to an AC outlet by a USB AC adaptor (commercially available). While the speaker is running only on power from the rechargeable built-in battery, the BLUETOOTH standby function turns off.
- Pair the speaker with a BLUETOOTH device in advance. If pairing information is not stored in the speaker, such as when the speaker is used for the first time after purchase, the speaker will not enter the BLUETOOTH standby mode.

**1** Connect the speaker to an AC outlet with a USB AC adaptor (commercially available).

**2** Turn on the speaker.

The  (power) indicator lights up in green.

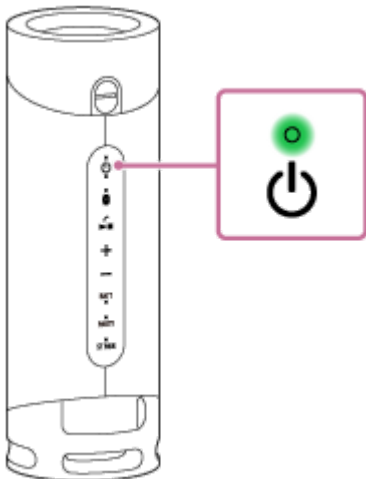

**3** Tap [Music Center] on your smartphone, iPhone, etc. to start up the application.



Music Center

**4** Tap [SRS-XB23].



5 Tap [Settings].



6 Tap [Power Option].

7 Tap [Bluetooth Standby].

8 Tap [ON] to set the BLUETOOTH standby mode to on.

### To turn off the BLUETOOTH standby function

Perform steps 3 to 7 again to turn off the BLUETOOTH standby function.

#### Hint

- When the BLUETOOTH standby function is activated, the  (power) indicator lights up in orange while the speaker is turned off.

#### Related Topic

- [Charging the speaker](#)
- [Turning the power on](#)
- [About the indicators](#)

Wireless Speaker  
SRS-XB23

## Auto power off (Auto Standby) function

---

If the speaker satisfies the following conditions for about 15 minutes, it turns off automatically.

At the time of purchase, the auto power off (Auto Standby) function is set to on.

- No operation on the speaker.
- The hands-free function of the connected mobile phone (smartphone) is set to off and the mobile phone (smartphone) is not playing music (audio), nor is it being operated. For details, refer to the operating instructions supplied with the mobile phone.
- The connected BLUETOOTH device, such as a WALKMAN<sup>®</sup>, is not playing music (audio), nor is it being operated.

### Hint

- You can turn on or off the auto power off (Auto Standby) function by using “Sony | Music Center.”

### Note

- When the speaker is connected to an iPhone/iPod touch via a BLUETOOTH connection, the auto power off (Auto Standby) function is disabled.

---

### Related Topic

- [What you can do with “Sony | Music Center”](#)

## Pairing and connecting with BLUETOOTH® devices

To pair with a second or subsequent BLUETOOTH device, perform the following pairing procedure for each device. Before operating the speaker, be sure to do the following:

- Place the BLUETOOTH device within 1 m (3.2 ft) of the speaker.
- Connect the speaker to an AC outlet via a USB AC adaptor (commercially available). Or charge the built-in battery sufficiently.
- Stop playback on a BLUETOOTH device.
- Turn down the volume of the BLUETOOTH device and speaker to avoid any sudden loud sound output from the speaker. Depending on the BLUETOOTH device, the volume of the device may be synchronized with the speaker.
- Prepare the operating instructions supplied with the BLUETOOTH device for reference.

### 1 Turn on the speaker.

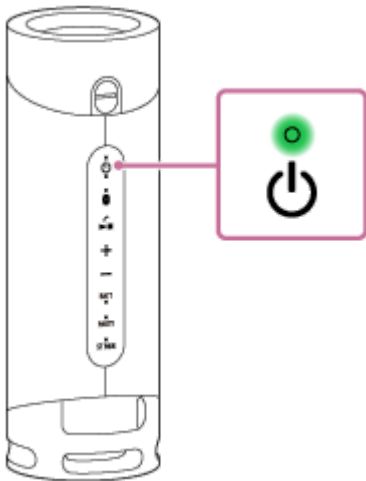

### 2 Check the status of the (BLUETOOTH) indicator.

When the indicator is double flashing

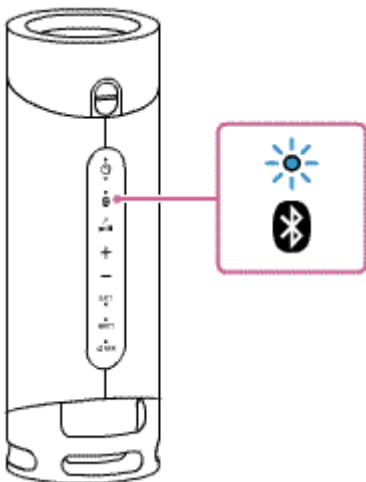



After you pair the speaker with a BLUETOOTH device for the first time since purchase or initialize the speaker (the speaker has no pairing information), the speaker automatically enters pairing mode when it is turned on. Proceed to step 4 .

### When the indicator is flashing slowly

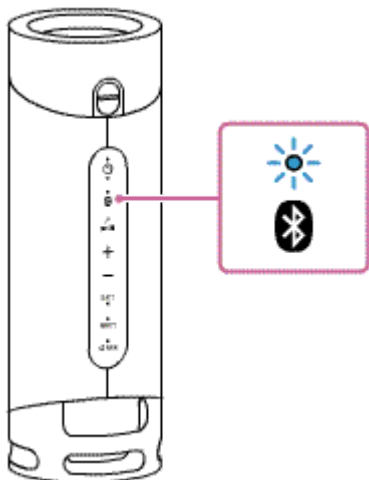

The speaker is searching for a BLUETOOTH device.

- To pair the speaker with a second or subsequent BLUETOOTH device (when the speaker has pairing information of other BLUETOOTH devices), proceed to step 3 .
- To reconnect to the BLUETOOTH device that has been registered (paired), proceed to step 4 . The speaker will automatically be connected just by turning on the BLUETOOTH function on the smartphone/iPhone. Depending on the BLUETOOTH device, it may be reconnected just by turning on the power to the speaker. For details, refer to the operating instructions supplied with the BLUETOOTH device.

### When the indicator stays lit

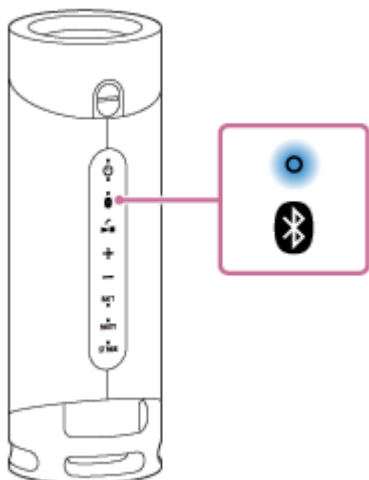

The speaker has been connected to the BLUETOOTH device.

To connect to other BLUETOOTH devices, follow one of the procedures below.

- To pair the speaker with a second or subsequent BLUETOOTH device (when the speaker has pairing information of other BLUETOOTH devices), proceed to step 3 .
- To reconnect to the BLUETOOTH device that has been registered (paired), proceed to step 4 . The speaker will automatically be connected just by turning on the BLUETOOTH function on the smartphone/iPhone.

### 3 Press the (BLUETOOTH) button.

You hear voice guidance (BLUETOOTH pairing) from the speaker and the  (BLUETOOTH) indicator starts double flashing (pairing mode).

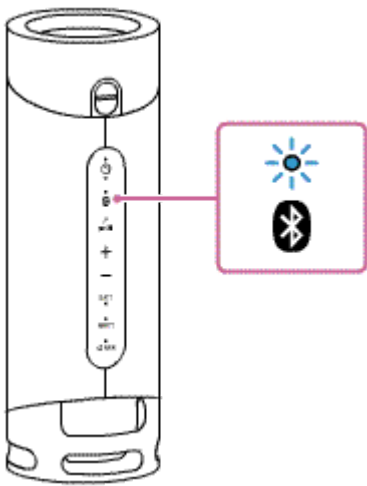

**4 Perform the pairing procedure on the BLUETOOTH device to detect the speaker.**

When a list of detected devices appears on the display of the BLUETOOTH device, select “SRS-XB23.”  
 If a passkey\* is required on the display of the BLUETOOTH device, enter “0000.”

\* The passkey may be called a “passcode,” “PIN code,” “PIN number,” or “password.”

**5 Make the BLUETOOTH connection from the BLUETOOTH device.**

When the BLUETOOTH connection is established, you hear voice guidance (BLUETOOTH connected) from the speaker and the activity of the  (BLUETOOTH) indicator changes from flashing to lit.

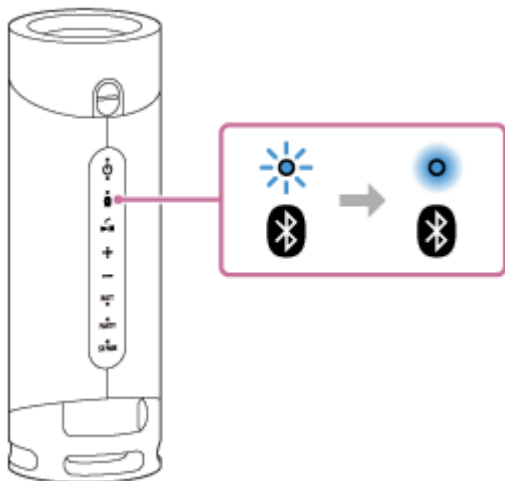

If the BLUETOOTH connection is not established, repeat from step **3**.

**Hint**

- As long as the BLUETOOTH function is activated on a BLUETOOTH device that has previously been connected with the speaker, the speaker is reconnected with the device right after it is turned on.
- For details on operating a BLUETOOTH device, refer to the operating instructions supplied with the BLUETOOTH device.
- Up to 2 BLUETOOTH devices can be connected to the speaker at the same time. When one of the devices starts playing back while playing back music on another device, the speaker switches the output and starts outputting the sound from the new device (Multi-device connection).

**Note**

- For Apple iOS devices, the unit is compatible with iOS 10.0 or later. A BLUETOOTH connection is not available on the devices with iOS 9.x or earlier.

- The pairing mode of the speaker is released after about 5 minutes and the  (BLUETOOTH) indicator flashes slowly. However, when pairing information is not stored in the speaker, such as at the factory settings, the pairing mode is not released. If the pairing mode is released before finishing the process, repeat from step **3**.
- The passkey of the speaker is "0000." If a passkey besides "0000" is set on the BLUETOOTH device, pairing cannot be done with the speaker.
- Once the BLUETOOTH devices are paired, there is no need to pair them again, except in the following cases:
  - Pairing information has been deleted after repair, etc.
  - The speaker is already paired with 8 devices and another device is to be paired.  
The speaker can be paired with up to 8 devices. If a new device is paired after 8 devices have already been paired, the device that was paired earliest is replaced by the new one.
  - The pairing information of the speaker has been deleted from the BLUETOOTH device.
  - The speaker is initialized.  
All pairing information will be deleted. If you initialize the speaker, it may not be able to connect your iPhone/iPod touch or computer. In this case, erase the pairing information of the speaker on your iPhone/iPod touch or computer, and then perform the pairing procedure again.
- The speaker can be paired with multiple devices, but can only play music from one paired device at a time.
- When using the Stereo Pair function or Party Connect function, you cannot use the multi-device connection.

---

## Related Topic

- [Listening to music of a device via BLUETOOTH connection](#)
- [Terminating the BLUETOOTH connection \(After use\)](#)
- [Switching the BLUETOOTH devices connected at the same time \(Multi-device-connection\)](#)

## Connecting with a computer via a BLUETOOTH connection (Windows)

Pairing is the process required to mutually register the information on BLUETOOTH devices to be connected wirelessly. It is necessary to pair a device with the speaker to be able to make a BLUETOOTH connection for the first time. Perform the same procedures to pair to other devices.

### Supported operation systems

Windows 10, Windows 8.1

Do the following before starting.

- Place your computer within 1 m (3.2 ft) of the speaker.
- Connect the speaker to an AC outlet via a USB AC adaptor (commercially available). Or charge the built-in battery sufficiently.
- Prepare the operating instructions supplied with the computer for reference.
- Stop playback on the computer.
- Turn down the volume of the computer and speaker to avoid any sudden loud sound output from the speaker.
- Set the speaker of your computer to on.  
If the speaker of your computer is set to  (mute), sound does not output on the BLUETOOTH speaker.

– When the speaker of your computer is set to on:



### 1 Prepare to search for the speaker on the computer.

#### For Windows 10

Select [ (Action Center)] – [Connect] in the taskbar on the right-bottom of the screen.

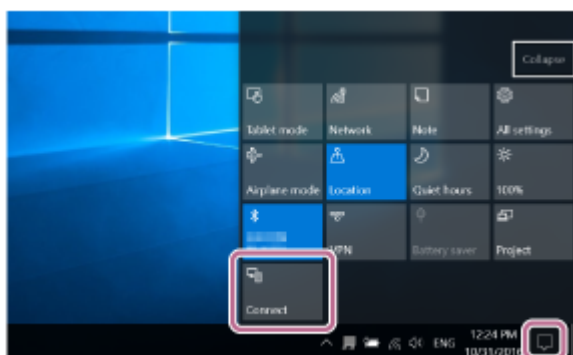

#### For Windows 8.1

Right-click on [Start], and then click [Control Panel].

When [All Control Panel Items] is displayed, select [Devices and Printers].

If the [Control Panel] screen appears instead of [All Control Panel Items], select [Large icons] or [Small icons] from the [View by] menu in the top right corner of the screen.

**2 Turn on the speaker.**

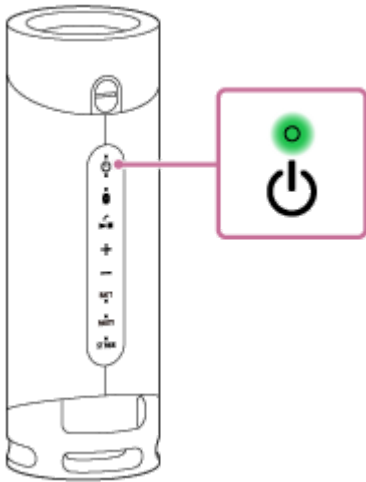

**3 Check the  (BLUETOOTH) indicator for activity.**

**When the indicator is double flashing**

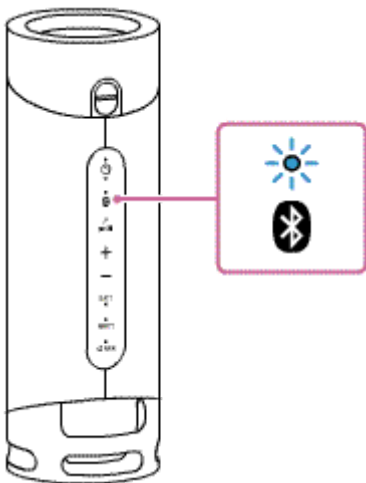

After you pair the speaker with a BLUETOOTH device for the first time since purchase or initialize the speaker (the speaker has no pairing information), the speaker automatically enters pairing mode when it is turned on. Proceed to step **5** .

**When the indicator is flashing slowly**

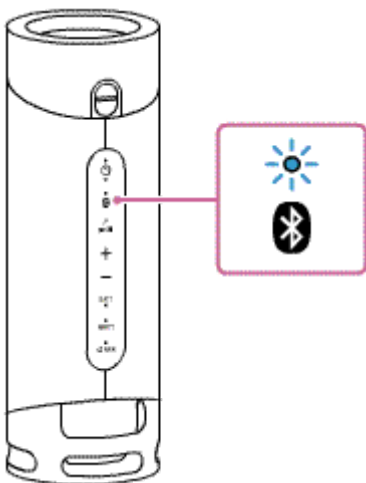

The speaker is searching for BLUETOOTH connections.

- To pair the speaker with a second or subsequent BLUETOOTH device (when the speaker has pairing information of other BLUETOOTH devices), proceed to step **4** .

- To reconnect the speaker with one of the BLUETOOTH devices that have been paired with the speaker before, proceed to step 5 .

Depending on the BLUETOOTH device, the speaker may be reconnected with the device right after it is turned on. For details, refer to the operating instructions supplied with your BLUETOOTH device.

### When the indicator stays lit

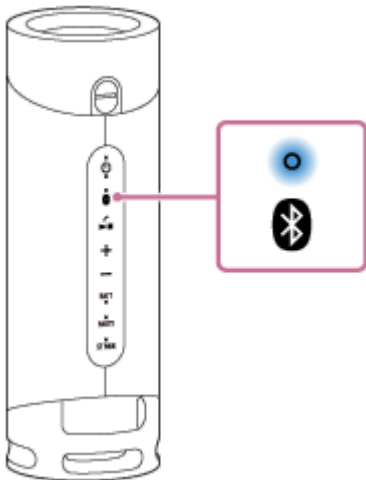

The speaker is already connected with one of the BLUETOOTH devices.

To connect the speaker with another BLUETOOTH device, do either of the following:

- To pair the speaker with a second or subsequent BLUETOOTH device (when the speaker has pairing information of other BLUETOOTH devices), proceed to step 4 .
- To reconnect the speaker with one of the BLUETOOTH devices that have been paired with the speaker before, proceed to step 5 .

#### 4 Press the (BLUETOOTH) button.

You hear voice guidance (BLUETOOTH pairing) from the speaker and the  (BLUETOOTH) indicator starts double flashing (pairing mode).

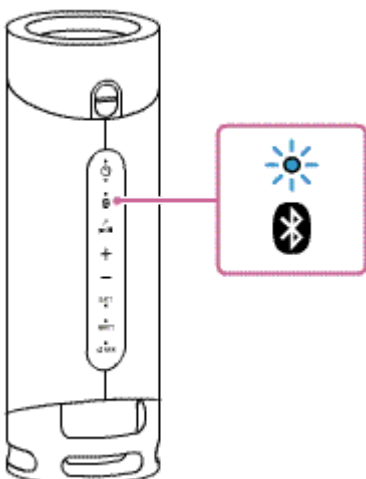

#### 5 Search for the speaker on the computer.

### Connecting the speaker to the computer via a BLUETOOTH connection

#### For Windows 10

1. Select [Connect] in the Action Center on the right-bottom of the screen.

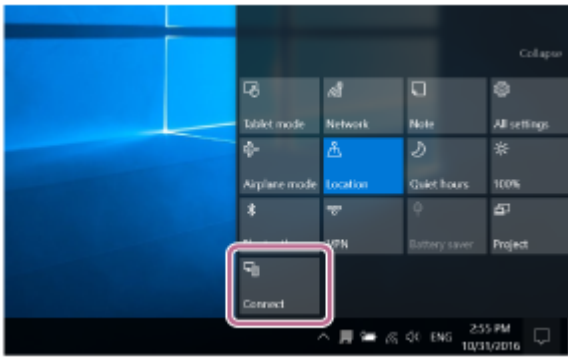

2. Select [SRS-XB23].

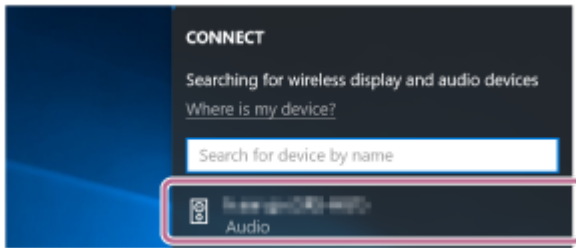

If [SRS-XB23] does not appear on the screen, repeat the procedure from step 4 .

After pairing, the BLUETOOTH connection establishes automatically and [Connected music] will be displayed on the screen. Proceed to step 7 .

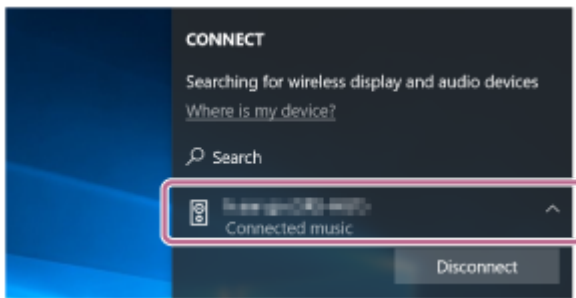

## For Windows 8.1

1. Click [Add a device].

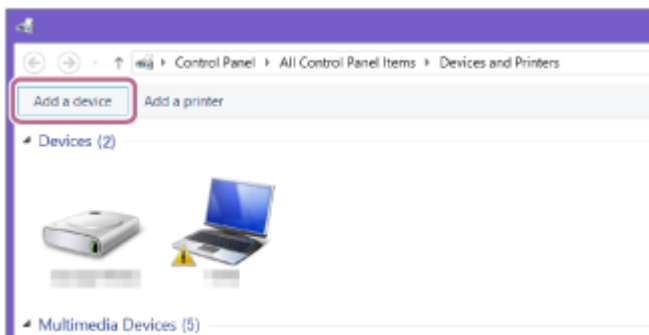

2. Select [SRS-XB23] and click [Next].

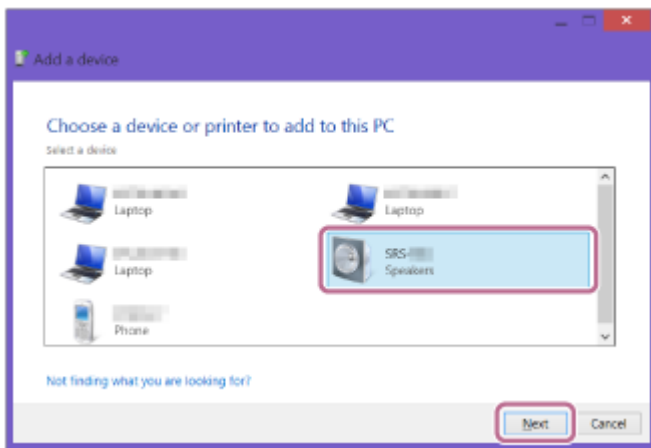

If a passkey\* is required, enter "0000."

If [SRS-XB23] does not appear, perform the operation again from step 4.

\* The passkey may be called a "passcode," "PIN code," "PIN number," or "password."

3. When the following screen appears, click [Close].  
The computer begins installing the driver.

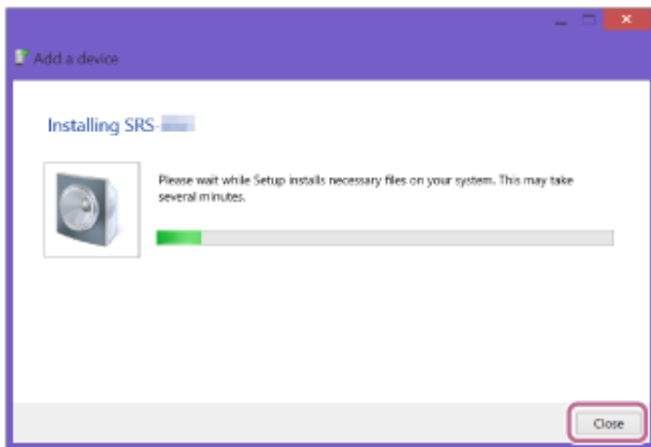

The "Ⓢ" mark will appear in the bottom left of the [SRS-XB23] icon during installation. When the "Ⓢ" mark disappears, driver installation is complete. Proceed to step 6.

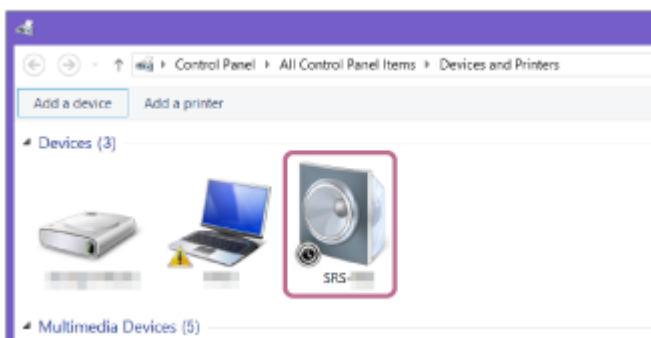

Depending on the computer, installation may take time. If driver installation takes too much time, the auto power off (Auto Standby) function of the speaker will cause it to turn off automatically. If this happens, turn on the speaker again.

## 6 Register the speaker to the computer.

### For Windows 10

After pairing, the BLUETOOTH connection establishes automatically and [Connected music] will be displayed on the screen. Proceed to step 7.

### For Windows 8.1



1. Right-click on [SRS-XB23] in [Devices] and select [Sound settings] from the menu that appears.

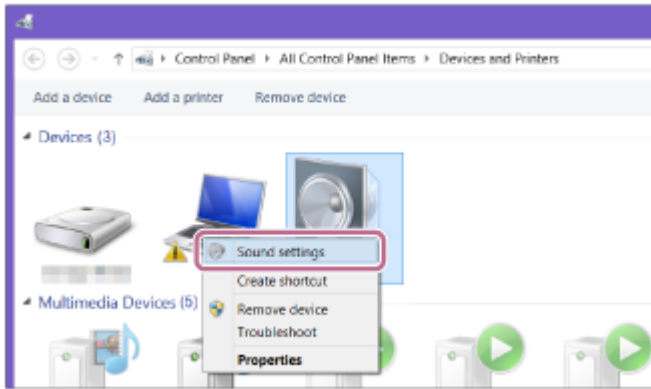

2. Confirm [SRS-XB23 Stereo] on the [Sound] screen.

- If there is a checkmark (green) on [SRS-XB23 Stereo], proceed to step 7.

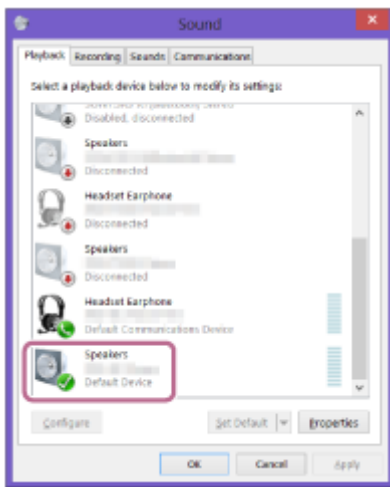

- If there is not a checkmark (green) on [SRS-XB23 Stereo], proceed to step 6-3.
- If [SRS-XB23 Stereo] does not appear, right-click on the [Sound] screen, and select [Show Disabled Devices] from the menu that appears. Then proceed to step 6-3.

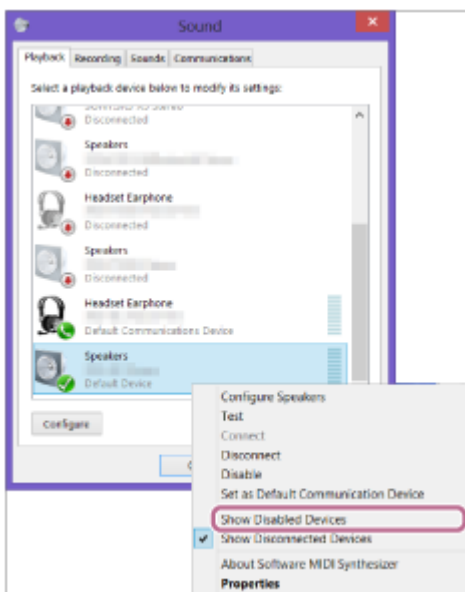

3. Right-click on [SRS-XB23 Stereo], and select [Connect] from the menu that appears.

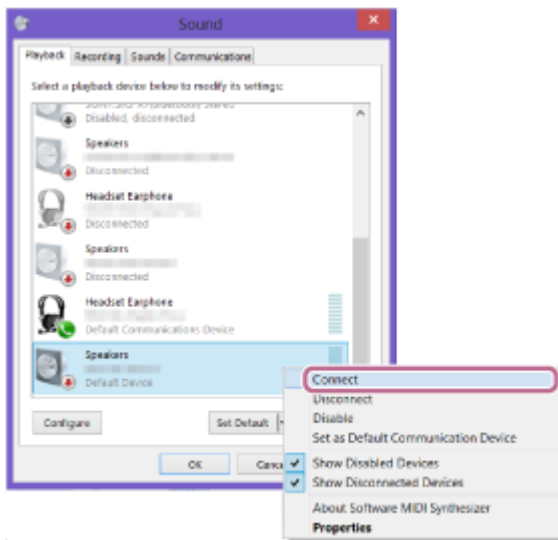

When the speaker is connected, a checkmark will appear on [SRS-XB23 Stereo] on the [Sound] screen. Proceed to step 7 .

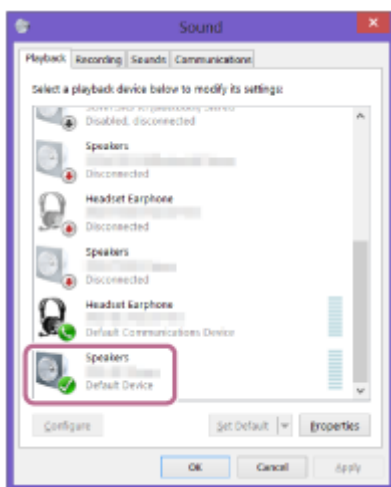

If you cannot click [Connect] for [SRS-XB23 Stereo], select [Disable] for the [Default Device] that currently has a checkmark (green).

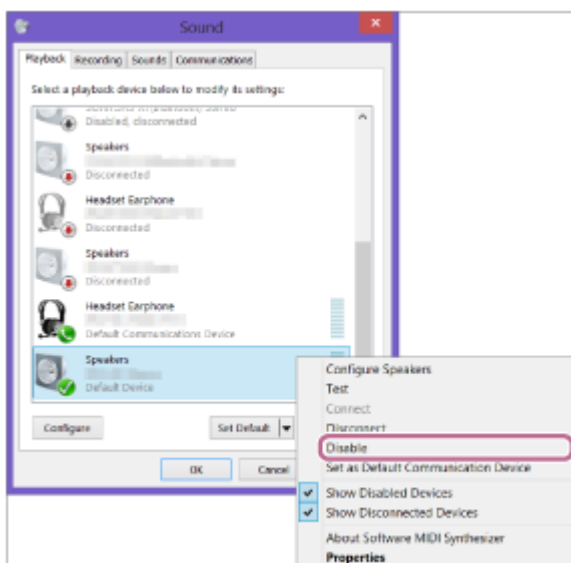

**7 Follow the on-screen instructions to establish a BLUETOOTH connection.**

When the BLUETOOTH connection is established, you hear voice guidance (BLUETOOTH connected) from the speaker and the activity of the  (BLUETOOTH) indicator changes from flashing to lit.

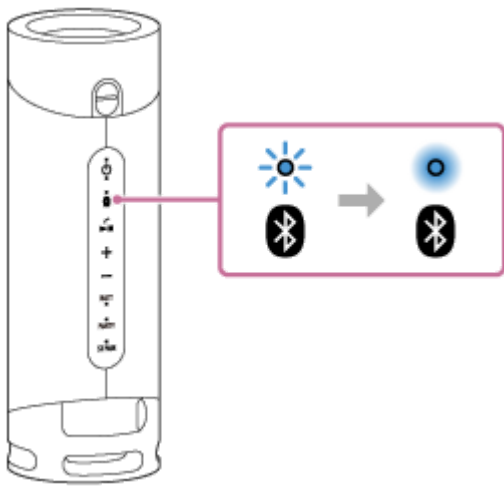

If the connection attempt fails, repeat the procedure from step ④ .

### Hint

- The above instructions on the computer are provided as an example. For details, refer to the operating instructions supplied with your computer. In addition, not all the computers are tested and found compatible with the above procedure and the procedure is not applicable to home-built computers.
- Up to 2 BLUETOOTH devices can be connected to the speaker at the same time. When one of the devices starts playing back while playing back music on another device, the speaker switches the output and starts outputting the sound from the new device (Multi-device connection).

### Note

- The pairing mode of the speaker is released after about 5 minutes and the  (BLUETOOTH) indicator flashes slowly. However, when pairing information is not stored in the speaker, such as at the factory settings, the pairing mode is not released. If the pairing mode is released before finishing the process, repeat from step ④ .
- Once BLUETOOTH devices are paired, there is no need to pair them again, except in the following cases:
  - Pairing information has been deleted after repair, etc.
  - The speaker is already paired with 8 devices and another device is to be paired.  
The speaker can be paired with up to 8 devices. If a new device is paired after 8 devices have already been paired, the device that was paired earliest is replaced by the new one.
  - The pairing information with the speaker has been deleted from the BLUETOOTH device.
  - The speaker is initialized.  
All pairing information will be deleted. If you initialize the speaker, it may not be able to connect your iPhone/iPod touch or computer. In this case, erase the pairing information of the speaker on your iPhone/iPod touch or computer, and then perform the pairing procedure again.
- The speaker can be paired with multiple devices, but can only play music from one paired device at a time.
- The passkey of the speaker is “0000.” If a passkey besides “0000” is set on the BLUETOOTH device, pairing cannot be done with the speaker.
- When using the Stereo Pair function or Party Connect function, you cannot use the multi-device connection.

### Related Topic

- [Listening to music of a device via BLUETOOTH connection](#)
- [Terminating the BLUETOOTH connection \(After use\)](#)
- [Switching the BLUETOOTH devices connected at the same time \(Multi-device-connection\)](#)



## Connecting with a computer via a BLUETOOTH connection (Mac)

Pairing is the process required to mutually register the information on BLUETOOTH devices to be connected wirelessly. It is necessary to pair a device with the speaker to be able to make a BLUETOOTH connection for the first time. Perform the same procedures to pair to other devices.

### Supported operation systems

macOS Catalina (version 10.15)

Do the following before starting.

- Confirm that the BLUETOOTH wireless technology is installed in your computer.
- Place your computer within 1 m (3.2 ft) of the speaker.
- Connect the speaker to an AC outlet via a USB AC adaptor (commercially available). Or charge the built-in battery sufficiently.
- Prepare the operating instructions supplied with the computer for reference.
- Stop playback on the computer.
- Turn down the volume of the computer and speaker to avoid any sudden loud sound output from the speaker.
- Depending on your computer, turn on the built-in BLUETOOTH adaptor.  
If you do not know how to turn on the BLUETOOTH adaptor or whether your computer has the built-in BLUETOOTH adaptor, refer to the operating instructions of your computer.
- Set the speaker of your computer to on.  
If the speaker of your computer is set to  (mute), sound does not output on the BLUETOOTH speaker.

– When the speaker of your computer is set to on:



### 1 Turn on the speaker.

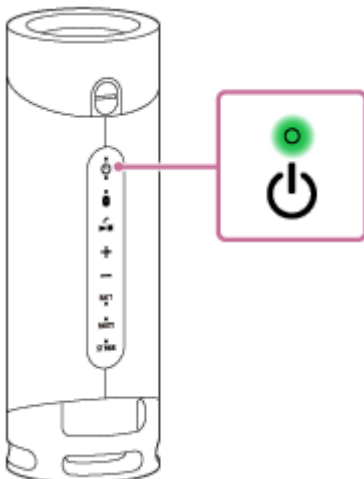

**2** Check the  (BLUETOOTH) indicator for activity.

**When the indicator is double flashing**

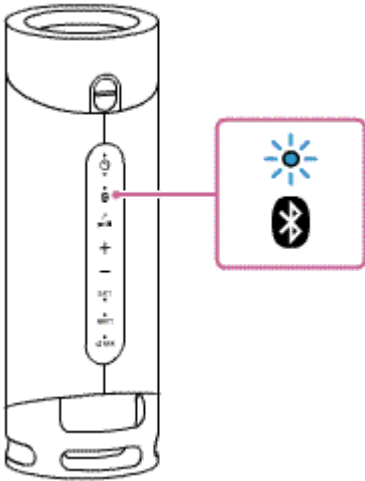

After you pair the speaker with a BLUETOOTH device for the first time since purchase or initialize the speaker (the speaker has no pairing information), the speaker automatically enters pairing mode when it is turned on. Proceed to step **4**.

**When the indicator is flashing slowly**

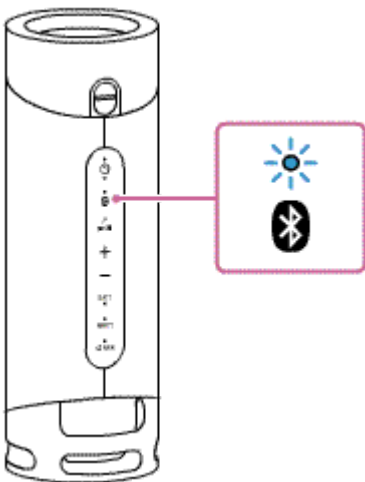

The speaker is searching for BLUETOOTH connections.

- To pair the speaker with a second or subsequent BLUETOOTH device (when the speaker has pairing information of other BLUETOOTH devices), proceed to step **3**.
- To reconnect the speaker with one of the BLUETOOTH devices that have been paired with the speaker before, proceed to step **4**.  
Depending on the BLUETOOTH device, the speaker may be reconnected with the device right after it is turned on. For details, refer to the operating instructions supplied with your BLUETOOTH device.

**When the indicator stays lit**

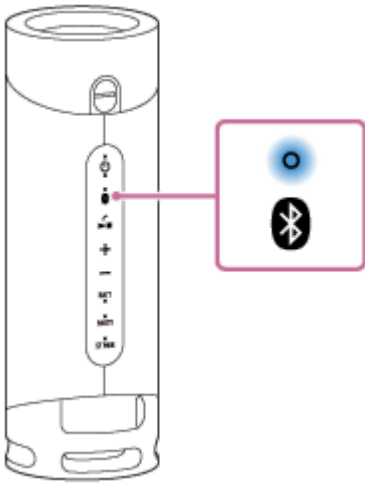

The speaker is already connected with one of the BLUETOOTH devices.

To connect the speaker with another BLUETOOTH device, do either of the following:

- To pair the speaker with a second or subsequent BLUETOOTH device (when the speaker has pairing information of other BLUETOOTH devices), proceed to step 3 .
- To reconnect the speaker with one of the BLUETOOTH devices that have been paired with the speaker before, proceed to step 4 .

### 3 Press the (BLUETOOTH) button.

You hear voice guidance (BLUETOOTH pairing) from the speaker and the  (BLUETOOTH) indicator starts double flashing (pairing mode).

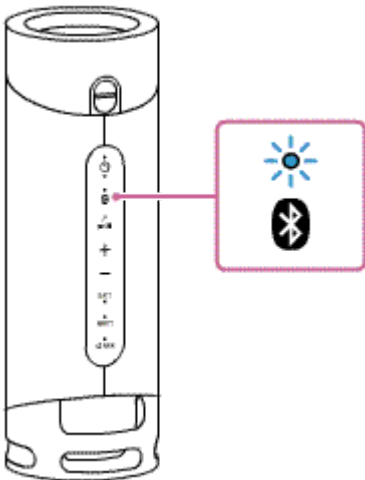

### 4 Search for the speaker on the computer.

1. Select [  (System Preferences)] - [Bluetooth] in the taskbar on the right-bottom of the screen.



2. Select [SRS-XB23] from the Bluetooth screen, then click [Pair].

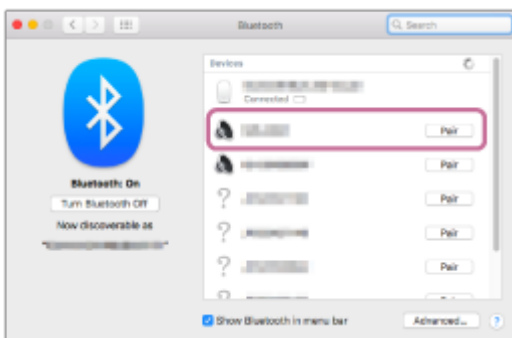

5 Follow the on-screen instructions to establish a BLUETOOTH connection.

When the BLUETOOTH connection is established, you hear voice guidance (BLUETOOTH connected) from the speaker and the activity of the  (BLUETOOTH) indicator changes from flashing to lit.

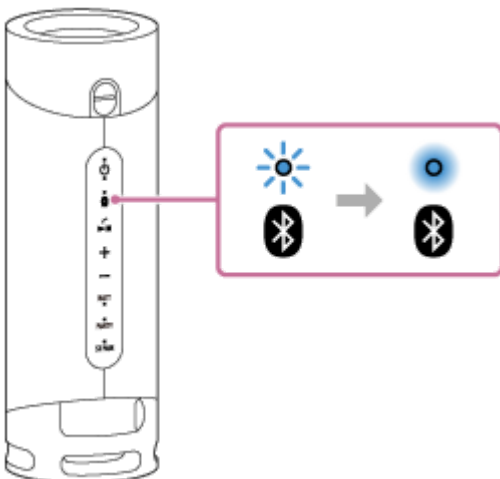

If the connection attempt fails, repeat the procedure from step 3 .

6 Click the speaker icon in the top-right of the screen and select [SRS-XB23] from [Output Device].

You can enjoy playing back music, etc. from your computer.



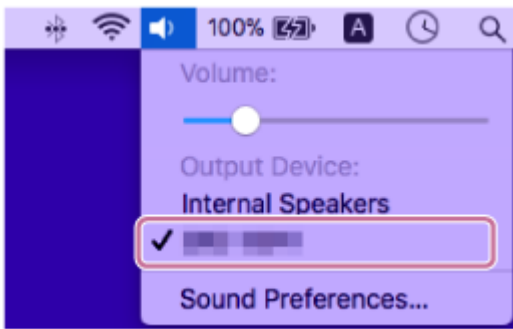

### Hint

- The procedure explained above is for guidance only. For details, refer to the operating instructions supplied with the computer. In addition, not all the computers are tested and found compatible with the above procedure and the procedure is not applicable to home-built computers.
- Up to 2 BLUETOOTH devices can be connected to the speaker at the same time. When one of the devices starts playing back while playing back music on another device, the speaker switches the output and starts outputting the sound from the new device (Multi-device connection).

### Note

- The pairing mode of the speaker is released after about 5 minutes and the  (BLUETOOTH) indicator flashes slowly. However, when pairing information is not stored in the speaker, such as at the factory settings, the pairing mode is not released. If the pairing mode is released before finishing the process, repeat from step 3.
- Once BLUETOOTH devices are paired, there is no need to pair them again, except in the following cases:
  - Pairing information has been deleted after repair, etc.
  - The speaker is already paired with 8 devices and another device is to be paired.  
The speaker can be paired with up to 8 devices. If a new device is paired after 8 devices have already been paired, the device that was paired earliest is replaced by the new one.
  - The pairing information with the speaker has been deleted from the BLUETOOTH device.
  - The speaker is initialized.  
All pairing information will be deleted. If you initialize the speaker, it may not be able to connect your iPhone/iPod touch or computer. In this case, erase the pairing information of the speaker on your iPhone/iPod touch or computer, and then perform the pairing procedure again.
- The speaker can be paired with multiple devices, but can only play music from one paired device at a time.
- The passkey of the speaker is "0000." If a passkey besides "0000" is set on the BLUETOOTH device, pairing cannot be done with the speaker.
- When using the Stereo Pair function or Party Connect function, you cannot use the multi-device connection.

---

### Related Topic

- [Listening to music of a device via BLUETOOTH connection](#)
- [Terminating the BLUETOOTH connection \(After use\)](#)
- [Switching the BLUETOOTH devices connected at the same time \(Multi-device-connection\)](#)

## Listening to music of a device via BLUETOOTH connection

You can enjoy listening to music of a BLUETOOTH device and operate it by the speaker via BLUETOOTH connection if it supports the following BLUETOOTH profiles.

### A2DP (Advanced Audio Distribution Profile)

Enables you to enjoy high-quality audio contents wirelessly.

### AVRCP (Audio Video Remote Control Profile)

Enables you to adjust the volume and operate to play, pause or skip to the beginning of the next/current track. Operations may vary depending on the BLUETOOTH device. Refer also to the operating instructions supplied with the BLUETOOTH device.

#### Note

- Make sure beforehand that the volume on the BLUETOOTH device and speaker are set to a moderate level to avoid sudden loud sound output from the speaker.  
Depending on the BLUETOOTH device, adjusting the volume of the speaker may not be possible on the BLUETOOTH device while playback on the device is stopped/paused.

### 1 Connect the speaker with the BLUETOOTH device.

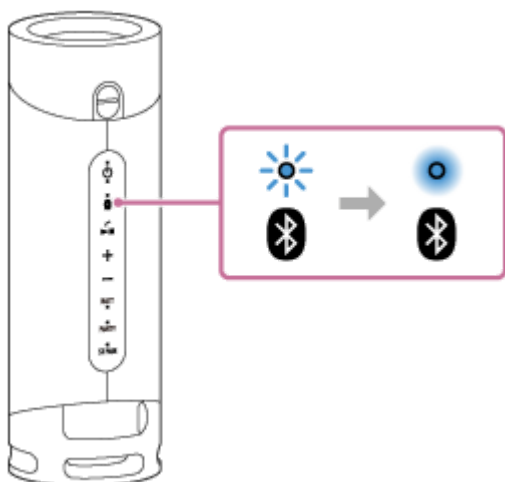

When the BLUETOOTH connection is established, you hear voice guidance (BLUETOOTH connected) from the speaker and the activity of the  (BLUETOOTH) indicator changes from flashing to lit.



### 2 Start playback on the BLUETOOTH device.

At the time of purchase, the audio output of the speaker is set for monaural audio playback. You can switch the audio output setting of the speaker between monaural and stereo with “Sony | Music Center.”

### 3 Adjust the volume by pressing the +/- (volume) buttons on the speaker or operating the BLUETOOTH device.

When you press the +/- (volume) buttons on the speaker or adjust the volume on the BLUETOOTH device, the  (power) indicator flashes once or 3 times.  
Depending on the BLUETOOTH device you are using, the  (power) indicator on the speaker may not flash even if you adjust the volume on the BLUETOOTH device.

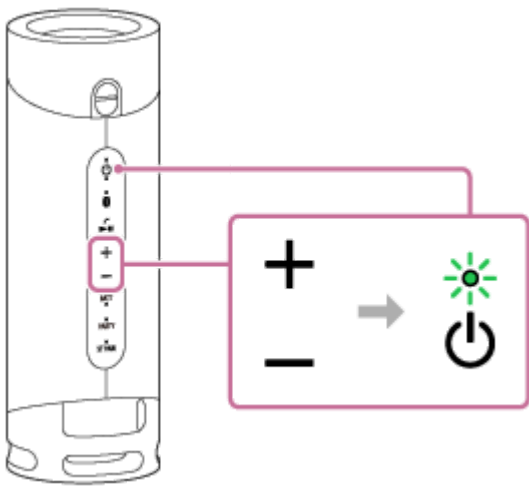

During playback, you can use the buttons on the speaker to perform the following operations.

### Pause

Press the ►|| (play)/ ☎ (call) button during playback to pause. Press it again to cancel pause.

### Skip to the beginning of the next track

Press the ►|| (play)/ ☎ (call) button twice quickly during playback.

### Skip to the beginning of the current or previous track\*

Press the ►|| (play)/ ☎ (call) button 3 times quickly during playback.

\* The above operations vary depending on the BLUETOOTH device in use.

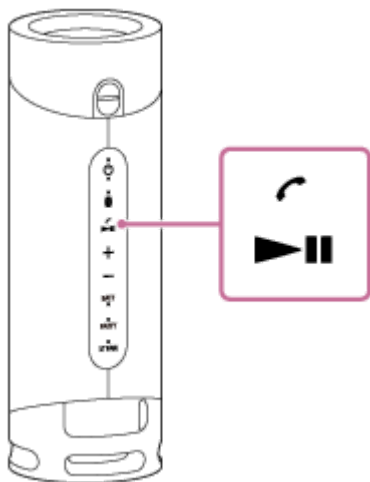

### Hint

- As long as the speaker is connected to an AC outlet by a USB AC adaptor (commercially available), the speaker's built-in battery is capable of charging itself even while music playback from the speaker is in progress. Depending on the type or specifications of the USB AC adaptor or the usage of the speaker, however, it may take a long time before charging completes. When you intend to use the speaker while charging the battery, turn down the speaker volume, or turn off the speaker and let the battery fully charge itself before using the speaker.
- When you set the volume to the maximum or minimum level on the speaker, the ⏻ (power) indicator flashes 3 times.

### Note

- For Apple iOS devices, the unit is compatible with iOS 10.0 or later. A BLUETOOTH connection is not available on the devices with iOS 9.x or earlier.
- If the communication condition is poor, the BLUETOOTH device may react incorrectly to the operations on the speaker.

- When using in a place with a high temperature, the volume may decrease to protect the built-in battery.
- If the built-in battery level is low, the maximum output of the speaker decreases.
- Depending on the BLUETOOTH device, it may be necessary to adjust the volume or set the audio output setting on the connected device.
- Noise or sound interruption may occur depending on the BLUETOOTH device connected with the speaker, the communication environment or the usage environment.

---

### Related Topic

- [Charging the speaker](#)
- [Terminating the BLUETOOTH connection \(After use\)](#)

5-011-826-11(2) Copyright 2020 Sony Corporation

## Switching between monaural audio playback and stereo audio playback

### Switching the audio output

At the time of purchase, the audio output of the speaker is set for monaural audio playback. You can change the audio output setting of the speaker with “Sony | Music Center”.

- 1 Tap [Music Center] on your smartphone, iPhone, etc. to start up the application.



Music Center

- 2 Tap [SRS-XB23].

- 3 Tap [Settings] - [Sound] - [Mono/Stereo] and select the audio output setting.

#### Hint

- To use an LDAC compatible BLUETOOTH device, change the audio output setting of the speaker to enable stereo audio playback.

### Placing the speaker vertically/horizontally

The speaker can be placed either vertically or horizontally (multi-placement).

While the audio output of the speaker is set for stereo audio playback, the audio in the left channel (left side) is output from the speaker component closer to the Sony logo inscription.

#### Vertical placement

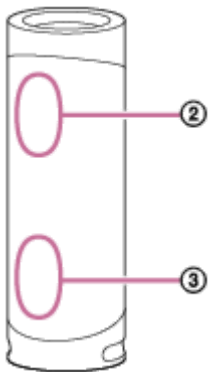

#### Horizontal placement

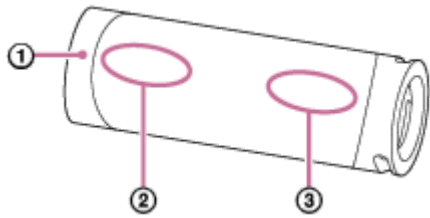

① : Sony logo

② : left channel (left side)

③ : right channel (right side)

Place the speaker with the Sony logo inscription located on your left-hand side.

This placement is recommended when the audio output of the speaker is changed to enable stereo audio playback.

**Note**

- Place the speaker on a flat, level surface. When placed on a sloped surface, the speaker may fall over or fall off the surface due to its own vibration, resulting in injuries, malfunctions, or performance degradation.

## Selecting the BLUETOOTH audio streaming playback quality (Codec)

The “Priority on sound quality” and “Priority on stable connection” modes are available as options for the playback quality of BLUETOOTH audio streaming. “Priority on sound quality” enables you to perform playback settings of, not only SBC, but also AAC and LDAC\*, so that you can enjoy high quality sound via BLUETOOTH connection, whereas “Priority on stable connection” provides you more stable BLUETOOTH audio streaming. “Priority on sound quality” is the default setting.

### Supported Codecs

- Priority on sound quality (default setting): AUTO is selected. Optimal codec is automatically selected from AAC, LDAC\*, and SBC.
- Priority on stable connection: SBC is selected.

\* To use an LDAC compatible BLUETOOTH device, change the audio output setting of the speaker to enable stereo audio playback.



### 1 Connect the speaker to an AC outlet via a commercially available USB AC adaptor.

#### Note

- Do not turn on the speaker.

### 2 Change the sound quality.

#### When using the buttons of the speaker

1. While holding the + (volume) button, press the  (BLUETOOTH) button until the  (BLUETOOTH) indicator flashes in blue.  
When the setting is changed to the “Priority on stable connection” mode, the  (BLUETOOTH) indicator flashes 3 times in blue.  
When the setting is changed to the “Priority on sound quality” mode, the  (BLUETOOTH) indicator flashes twice in blue.

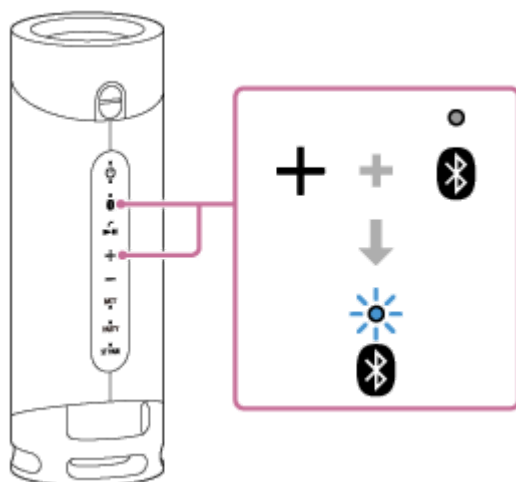

#### When using “Sony | Music Center”

1. Press the  (power) button to turn on the speaker.

#### Hint

- Speaker operations with "Sony | Music Center" are available even while the speaker is running on power from the rechargeable built-in battery.

2. Pair the speaker with a BLUETOOTH device, such as a smartphone or iPhone.  
When a BLUETOOTH connection is established, you hear voice guidance (BLUETOOTH connected) from the speaker.
3. Tap [Music Center] on your smartphone, iPhone, etc. to start up the application.



Music Center

4. Tap [SRS-XB23].
5. Tap [Settings] - [Other Settings] - [Bluetooth Codec], and then select a codec.  
[AUTO]: Priority on sound quality  
[SBC]: Priority on stable connection

#### Note

- Noise or sound interruption may occur in the [AUTO] (Priority on sound quality) mode, depending on the setting of your BLUETOOTH device and ambient conditions. In this case, change the speaker to the [SBC] (Priority on stable connection) mode.

---

#### Related Topic

- [Using the BLUETOOTH standby function](#)
- [What you can do with "Sony | Music Center"](#)
- [Switching between monaural audio playback and stereo audio playback](#)



Wireless Speaker  
SRS-XB23

## Terminating the BLUETOOTH connection (After use)

---

When you finish playing music with the BLUETOOTH device, perform any of the following operations to terminate the BLUETOOTH connection.

When the BLUETOOTH connection is disconnected, you hear voice guidance (BLUETOOTH disconnected) from the speaker.

- Turn off the BLUETOOTH function on the BLUETOOTH device. For details, refer to the operating instructions supplied with the device.
- Turn off the BLUETOOTH device.
- Turn off the speaker.

### Hint

- When using the Stereo Pair function, if you turn off one speaker, the other speaker is automatically turned off. The BLUETOOTH connection between them is disconnected.
- When you finish playing music, the BLUETOOTH connection may terminate automatically depending on the BLUETOOTH device.

---

### Related Topic

- [What you can do with "Sony | Music Center"](#)
- [Auto power off \(Auto Standby\) function](#)

## Switching the BLUETOOTH devices connected at the same time (Multi-device-connection)

Up to 2 BLUETOOTH devices can be connected to the speaker at the same time. When one of the devices starts playing back while playing back music on another device, the speaker switches the output and starts outputting the sound from the newly connected device.

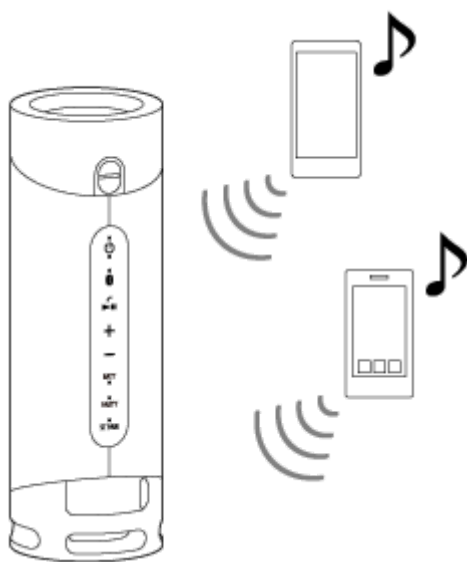

- Operations may vary depending on the BLUETOOTH device. Also, it may not be connected depending on the combination of devices. For details, refer to the operating instructions supplied with the device.

**1** Press the  (power) button to turn on the speaker.

**2** Pair the speaker with BLUETOOTH devices such as smartphones or iPhone devices.

You can connect with up to 2 BLUETOOTH devices at the same time by A2DP/AVRCP.

When a BLUETOOTH connection is established, you hear voice guidance (BLUETOOTH connected) from the speaker.

### Note

- When using the Stereo Pair function or Party Connect function, you cannot use the multi-device connection.
- You may not be able to make 2 BLUETOOTH connections at the same time depending on the BLUETOOTH device.
- The multi-device connection is not compatible with HFP (Hands-free Profile) and HSP (Headset Profile). Therefore, when using the multi-device connection, you cannot use the hands-free function.
- The multi-device connection is not compatible with HFP (Hands-free Profile). Therefore, when using the multi-device connection, the remaining battery power of the speaker is not displayed on the Android smartphone or the iPhone/iPod touch.
- You cannot turn off the multi-device connection function.

### To disconnect the multi-device connection

- Press the  (power) button to turn off the speaker.

- When you turn off the BLUETOOTH function on the desired BLUETOOTH device or the power to the device, you hear voice guidance (BLUETOOTH disconnected) from the speaker and the BLUETOOTH connection with the speaker is disconnected.

---

### Related Topic

- [Pairing and connecting with BLUETOOTH® devices](#)

5-011-826-11(2) Copyright 2020 Sony Corporation

Wireless Speaker  
SRS-XB23

## Listening to music wirelessly with 2 speakers (Stereo Pair function)

To use the Stereo Pair function, 2 SRS-XB23 speakers are required. By connecting 2 speakers via BLUETOOTH connection, you can enjoy more powerful sound.

One speaker plays the sound on the right channel (right side), while the other speaker plays the sound on the left channel (left side) for stereo playback between the speakers.

For Apple iOS devices, the unit is compatible with iOS 10.0 or later. A BLUETOOTH connection is not available on the devices with iOS 9.x or earlier.

### Note

- Before establishing a connection between the speaker and a BLUETOOTH device, turn down the volume of the speaker and the device or stop music playback on the device to avoid any sudden loud sound output from the speaker.

### 1 Place 2 speakers within 1 m (3.2 ft) each other, and then turn on both speakers.

The  (power) indicator lights up.

The  (BLUETOOTH) indicator flashes slowly.

If the BLUETOOTH device which has been connected before is nearby, the speaker may be connected to the device automatically, and then the  (BLUETOOTH) indicator may be lit. In this case, turn off the BLUETOOTH function on the BLUETOOTH device or turn off the BLUETOOTH device.

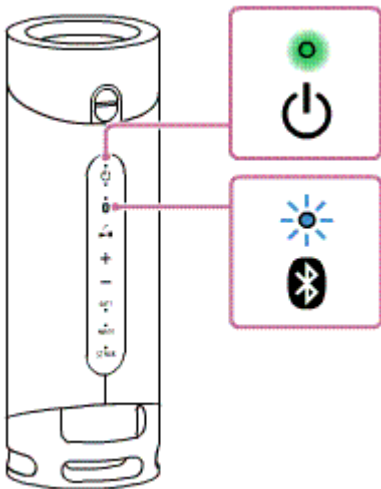

When the speaker has no pairing information, for example when you use the BLUETOOTH function for the first time after purchase, the  (BLUETOOTH) indicator keeps double flashing in blue.



### 2 On either one of the speakers, press the ST PAIR (Stereo Pair) button.

You hear a beep and the  (BLUETOOTH) indicator and the ST PAIR (Stereo Pair) indicator flash. In about 6 seconds, the ST PAIR (Stereo Pair) indicator will stop flashing and stay lit with a beep.

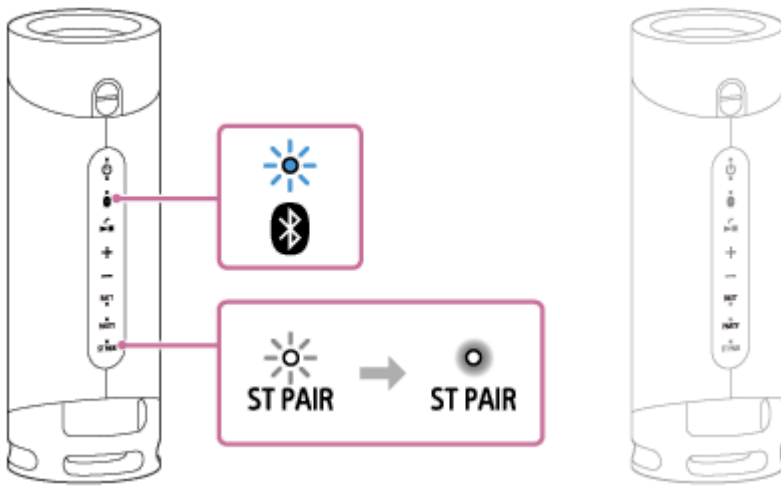

**3 On the other speaker, press the ST PAIR (Stereo Pair) button.**

The ST PAIR (Stereo Pair) indicator lights.

You hear the “Left” or “Right” voice guidance from each speaker and both speakers are connected by the Stereo Pair function.

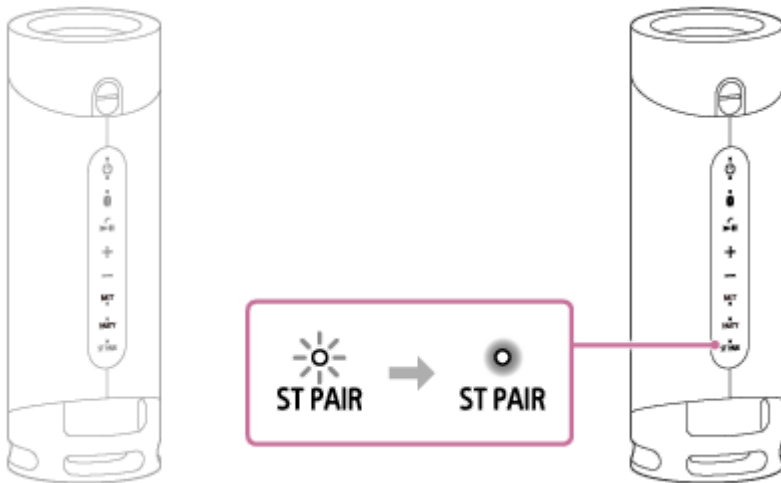

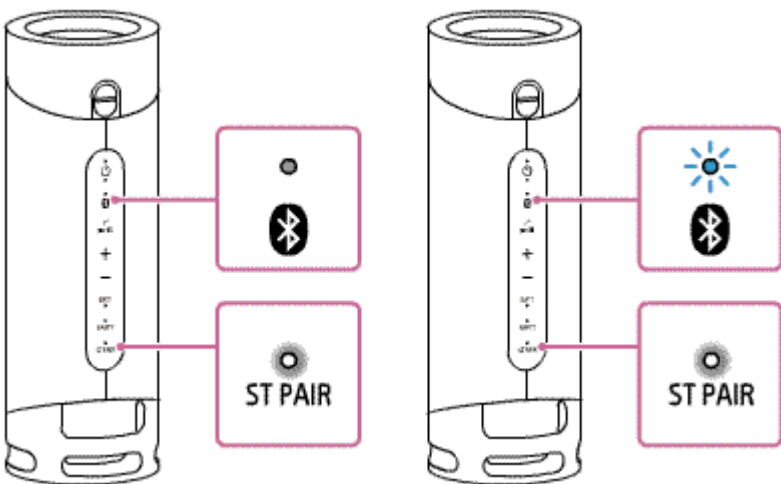

When the speakers are connected by the Stereo Pair function, the ST PAIR (Stereo Pair) indicators on both speakers stay lit and the  (BLUETOOTH) indicator on either one of the speakers turns off.



**Hint**

- When a BLUETOOTH connection is immediately established between 2 speakers, the  (BLUETOOTH) indicator and the ST PAIR (Stereo Pair) indicator may not flash and the ST PAIR (Stereo Pair) indicator may light instead.
- Set up the second speaker within 1 minute. If you do not set it up within 1 minute, the setting of the first speaker will be canceled.

- 4 Operate the speaker in which the  (BLUETOOTH) indicator is flashing to make a BLUETOOTH connection with a BLUETOOTH device.

When the BLUETOOTH connection is established, you hear voice guidance (BLUETOOTH connected) from the speaker and the activity of the  (BLUETOOTH) indicator changes from flashing to lit.

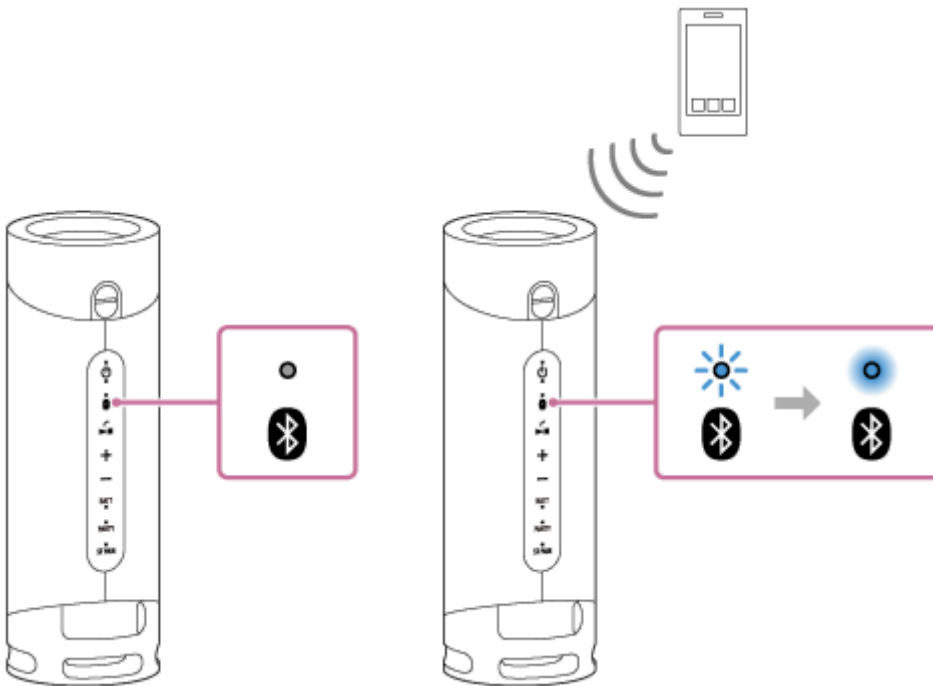

- 5 Start playback on the BLUETOOTH device, and adjust the volume to moderate level.

- 6 Press the +/- (volume) buttons on one of the speakers to adjust the volume.

Volume adjustment of one speaker is reflected in the other.

## To swap the right (right side) and left (left side) audio channels

On either one of the speakers, press and hold the ST PAIR (Stereo Pair) button behind the cap located on the rear side of the speaker.

You hear voice guidance and the right and left audio channels are swapped.

### Hint

- By using “Sony | Music Center,” you can establish a connection with the Stereo Pair function or terminate the Stereo Pair function. This, however, requires that you update the version of the speaker’s software to Ver. 3700 or later on all of the speakers. With the speakers whose software version is earlier than Ver. 3700, “Sony | Music Center” fails to establish a connection with the Stereo Pair function or terminate the Stereo Pair function.
- When making or receiving a call, only operate the speaker in which the  (BLUETOOTH) indicator lights up.
- If any other BLUETOOTH device(s), such as a BLUETOOTH mouse or BLUETOOTH keyboard, is connected to the BLUETOOTH device that is connected to the speaker, there may be distorted sound or noise in the speaker output. In this case, terminate the BLUETOOTH connection between the BLUETOOTH device and other BLUETOOTH device(s).
- When using the Stereo Pair function, the codec automatically switches to SBC.
- Turning off the speaker does not terminate the Stereo Pair function. When the speaker is turned back on, it attempts to establish a connection with the Stereo Pair function. To use the Stereo Pair function, turn on the other speaker within 1 minute. While the BLUETOOTH standby function is activated both on the 2 speakers, however, turning on either speaker also turns on the other automatically and establishes a connection with the Stereo Pair function between the 2 speakers.

## Note

- After you restart or initialize either of the speakers while the Stereo Pair function is activated, be sure to press the ST PAIR (Stereo Pair) button on the other speaker to terminate the Stereo Pair function. If you continue to use the speaker without terminating the Stereo Pair function, you will have a problem, such as a failure to establish a BLUETOOTH connection or a sound interruption.

---

## Related Topic

- [Using the BLUETOOTH standby function](#)
- [Updating the pre-installed software](#)

5-011-826-11(2) Copyright 2020 Sony Corporation

## Terminating the Stereo Pair function

To terminate the Stereo Pair function, follow the procedure below.

- 1 Press the ST PAIR (Stereo Pair) button.

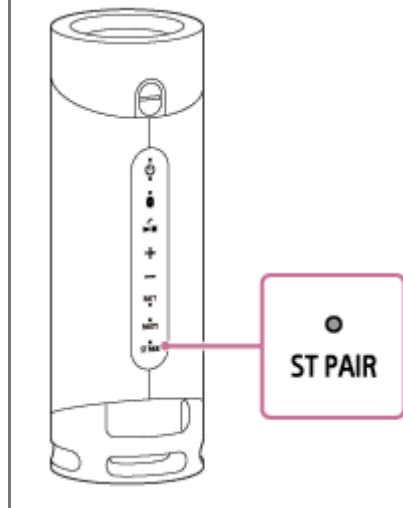

### Hint

- Turning off the speaker does not terminate the Stereo Pair function. When the speaker is turned back on, it attempts to establish a connection with the Stereo Pair function. To use the Stereo Pair function, turn on the other speaker within 1 minute. While the BLUETOOTH standby function is activated both on the 2 speakers, however, turning on either speaker also turns on the other automatically and establishes a connection with the Stereo Pair function between the 2 speakers.
- If you want to use the speaker that had been used as one of the speakers of the Stereo Pair function by itself, press the (power) button to turn on the speaker, then press the ST PAIR (Stereo Pair) button to terminate the Stereo Pair function.
- To terminate the Stereo Pair function while using 2 speakers, press the ST PAIR (Stereo Pair) button. A beep is heard, and then the Stereo Pair function is terminated.
- By using "Sony | Music Center," you can establish a connection with the Stereo Pair function or terminate the Stereo Pair function.

### Related Topic

- [Using the BLUETOOTH standby function](#)
- [Listening to music wirelessly with 2 speakers \(Stereo Pair function\)](#)



## Enjoying wireless playback using multiple speakers (Party Connect function)

By connecting multiple devices (up to 100 devices) compatible with the Party Connect function, you can liven up parties with loud volume.

Products compatible with the Wireless Party Chain function are not applicable for connection.

### Devices compatible with the Party Connect function:

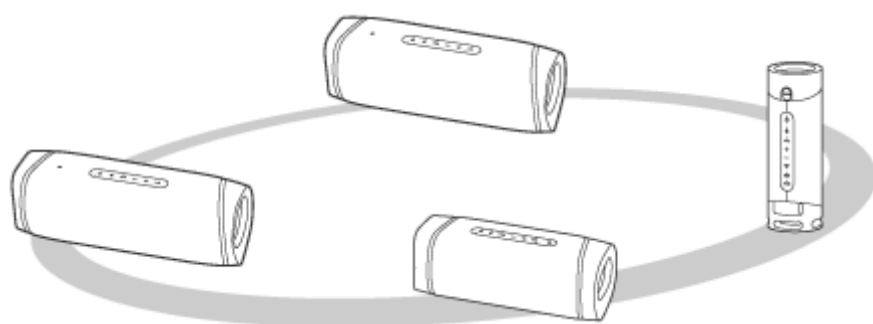

SRS-XB43, SRS-XB33, SRS-XB23

Before operating the speaker, make sure that all speakers to be connected within 1 m (3.2 ft) of the device.



### 1 Set up the first speaker.

The following operation is an example of setting SRS-XB23 as the first speaker. Refer to the operating instructions supplied with the device you are using to set up other devices compatible with the Party Connect function.

1. Press the  (power) button on the speaker.  
The  (BLUETOOTH) indicator flashes in blue.
2. Connect the BLUETOOTH device to the speaker via BLUETOOTH connection.  
Depending on the type of BLUETOOTH device to be connected, see the following topics.

[Pairing and connecting with BLUETOOTH® devices](#)



[Connecting with a computer via a BLUETOOTH connection \(Windows\)](#)

[Connecting with a computer via a BLUETOOTH connection \(Mac\)](#)

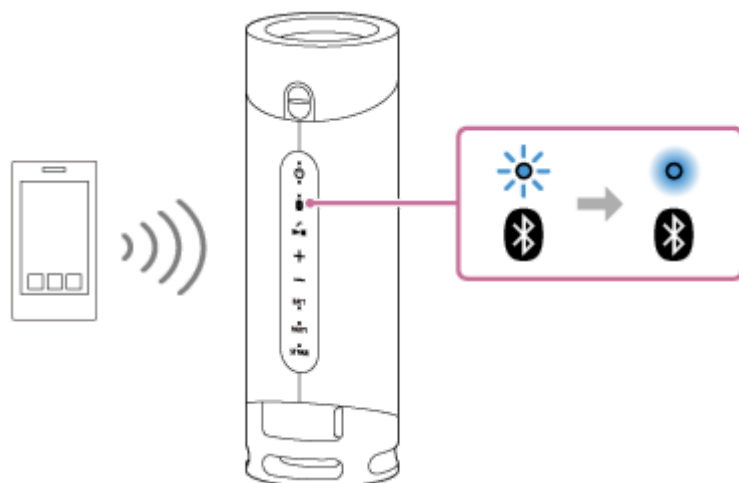
When the BLUETOOTH connection is established, you hear voice guidance (BLUETOOTH connected) from the speaker and the activity of the  (BLUETOOTH) indicator changes from flashing to lit.





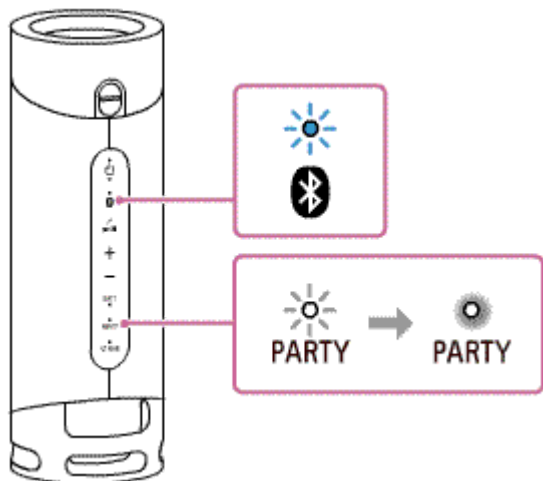

3. Press the PARTY (Party Connect) button.

You hear a beep and the  (BLUETOOTH) indicator and the PARTY (Party Connect) indicator flash. In about 6 seconds, the PARTY (Party Connect) indicator will stop flashing and stay lit with a beep. The activity of the  (BLUETOOTH) indicator changes from lit to flashing for a time.



## 2 Connect a second or more speakers.

The following operation is an example of connecting SRS-XB23 as the second speaker. Refer to the operating instructions supplied with the device you are using to connect other devices compatible with the Party Connect function.

1. Press the  (power) button on the speaker to be connected.  
The  (BLUETOOTH) indicator of the speaker you turned on flashes in blue.
2. Press the PARTY (Party Connect) button.  
A beep is heard, the  (BLUETOOTH) indicator flashes and the PARTY (Party Connect) indicator lights up, then the  (BLUETOOTH) indicator turns off. The PARTY (Party Connect) indicator continues to stay lit.

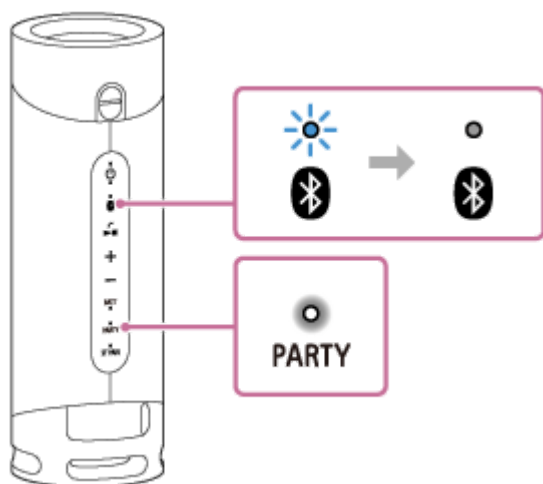

### Hint

- Connect the second speaker within 1 minute. After 1 minute or more, the speaker setting is canceled.

3. To connect additional speakers, repeat steps **2** – 1 to 2.

### Hint

- When connecting a third or more speakers, connect each one within 30 seconds of connecting the previous speaker. After 30 seconds or more, the speaker cannot be connected.
- If you want to add another speaker after connecting (30 seconds or more), operate step **1** – 3, then operate steps **2** – 1 to 2.

When a connection with the Party Connect function is established, the PARTY (Party Connect) indicators on all the speakers stay lit. Then, the activity of the  (BLUETOOTH) indicator on the first speaker changes from flashing to lit.

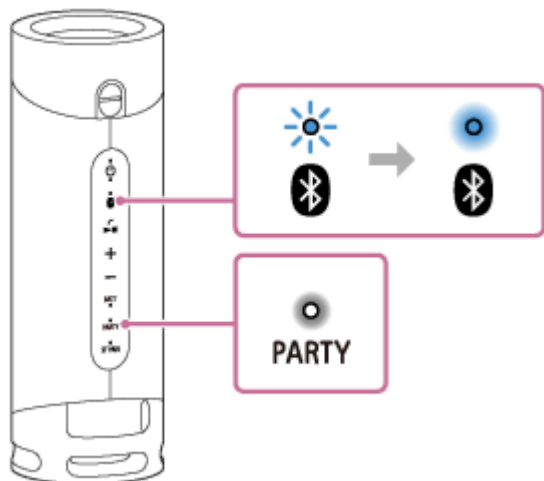

### 3 Start playback on the connected BLUETOOTH device and adjust the volume level.

The same music is played from all speakers.

When adjusting the volume on the BLUETOOTH device or the speaker connected with the device (the speaker set up as the first one), the volumes of all speakers are automatically adjusted. For other speakers (the second or later speaker set), you can also adjust the volume on each other.

#### Hint

- By using “Sony | Music Center,” you can establish a connection with the Party Connect function or terminate the Party Connect function. This, however, requires that you update the version of the speaker’s software to Ver. 3700 or later on all of the speakers. With the speakers whose software version is earlier than Ver. 3700, “Sony | Music Center” fails to establish a connection with the Party Connect function or terminate the Party Connect function.
- When using the Party Connect function, the codec automatically switches to SBC.

#### Note

- When watching movies using the Party Connect function, there may be a gap between video and audio.

#### Related Topic

- [Updating the pre-installed software](#)

## Terminating the Party Connect function

---

### To terminate all connections and exit the Party Connect function

Turn off the speaker which the  (BLUETOOTH) indicator lights up (the speaker set up as the first one).

### To terminate only one speaker

Turn off the speaker you want to release (the second or later speaker set).

#### Hint

- By using “Sony | Music Center,” you can establish a connection with the Party Connect function or terminate the Party Connect function.

---

#### Related Topic

- [Enjoying wireless playback using multiple speakers \(Party Connect function\)](#)

## Enjoying switching the sound effects

You can enjoy 2 different sound effects.  
When you purchase the speaker, the EXTRA BASS mode is set.

| Sound effect name | The color of the STAMINA indicator                   | Feature          |
|-------------------|--|------------------|
| STAMINA           | Orange (EXTRA BASS OFF)                              | Power saving     |
| EXTRA BASS        | Turns off (EXTRA BASS ON) (factory default settings) | Heavy bass sound |

### Switching the EXTRA BASS setting using a button of the speaker

To switch the sound effect from EXTRA BASS mode to STAMINA mode, press and hold the BATT (battery)/  STAMINA button for about 3 seconds.  
The STAMINA indicator lights up in orange and the sound effect is switched to STAMINA mode.

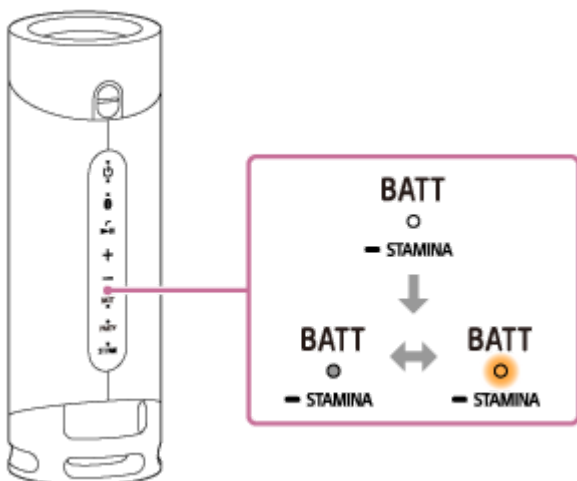

If you press and hold the BATT (battery)/  STAMINA button for about 3 seconds once again, the STAMINA indicator will turn off and the sound effect will be switched back to EXTRA BASS mode.

### When setting the Sound Effect with “Sony | Music Center”

1. Tap [Music Center] on your smartphone, iPhone, etc. to start up the application.



Music Center

2. Tap [SRS-XB23].
3. Tap [Settings] - [Sound] - [Sound Effect] to select the sound effect.
  - STAMINA
  - EXTRA BASS

### Note

- Depending on the music, the EXTRA BASS effects may not be so noticeable.

---

### Related Topic

- [Listening to music of a device via BLUETOOTH connection](#)
- [What you can do with “Sony | Music Center”](#)

5-011-826-11(2) Copyright 2020 Sony Corporation

Wireless Speaker  
SRS-XB23

## Receiving a call

You can enjoy hands-free calls with a BLUETOOTH mobile phone that supports the BLUETOOTH profile HFP (Hands-free Profile) or HSP (Headset Profile) via BLUETOOTH connection.

- If your BLUETOOTH mobile phone supports both HFP and HSP, set it to HFP.
- Operations may vary depending on the BLUETOOTH mobile phone. Refer to the operating instructions supplied with the mobile phone.

### About ring tones

When an incoming call arrives, playback pauses and a ring tone will be heard via the speaker. The ring tone varies in the following ways, depending on your BLUETOOTH mobile phone.

- Ring tone set on the speaker
- Ring tone set on the BLUETOOTH mobile phone
- Ring tone set on the BLUETOOTH mobile phone only for a BLUETOOTH connection

#### 1 Connect the speaker with a BLUETOOTH mobile phone.

When the BLUETOOTH connection is established, you hear voice guidance (BLUETOOTH connected) from the speaker and the activity of the  (BLUETOOTH) indicator changes from flashing to lit.

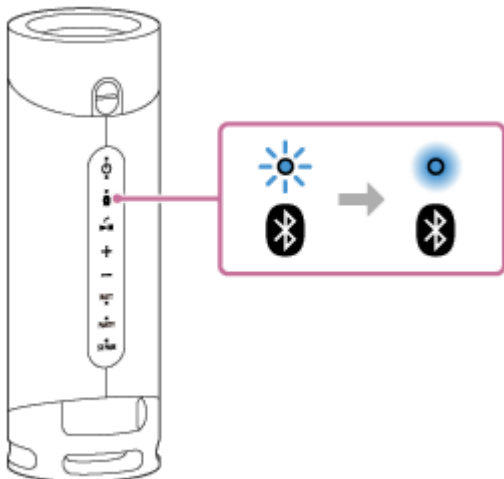

#### When using the Stereo Pair function or Party Connect function

Connect to the speaker in which the  (BLUETOOTH) indicator flashes in blue. In the following steps and operations during a hands-free call, operate the speaker that is connected to the BLUETOOTH mobile phone.

#### 2 Press the (play)/ (call) button when a call is received.

Talk into the microphone of the speaker.

When an incoming call arrives, playback pauses and a ring tone is heard from the speaker.

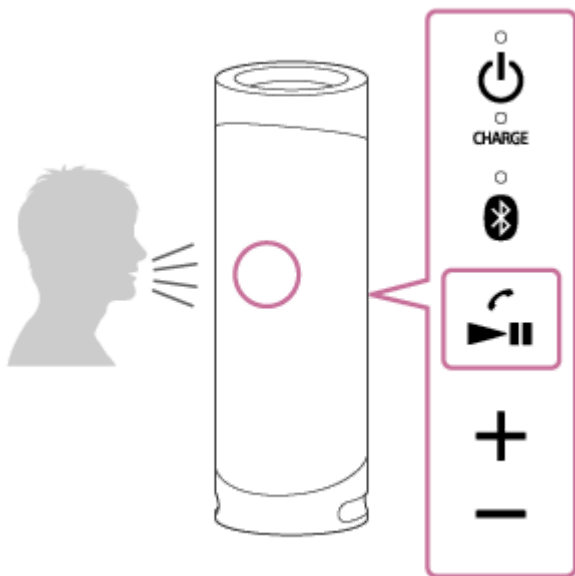

### If no ring tone is heard via the speaker

- The speaker may not be connected with a BLUETOOTH mobile phone with HFP or HSP. Check the connection status on the BLUETOOTH mobile phone.
- If more than one BLUETOOTH devices are connected to the speaker (Multi-device connection), you cannot receive a phone call. Cancel the multi-device connection. Terminate the BLUETOOTH connection or turn off the BLUETOOTH function of the BLUETOOTH devices other than the BLUETOOTH mobile phone in use.

### 3 While the phone is ringing or a phone conversation is in progress, adjust the volume by pressing the +/- (volume) buttons on the speaker or operating the BLUETOOTH mobile phone.

When you press the +/- (volume) buttons on the speaker or adjust the volume on the BLUETOOTH mobile phone, the  (power) indicator flashes once or 3 times.

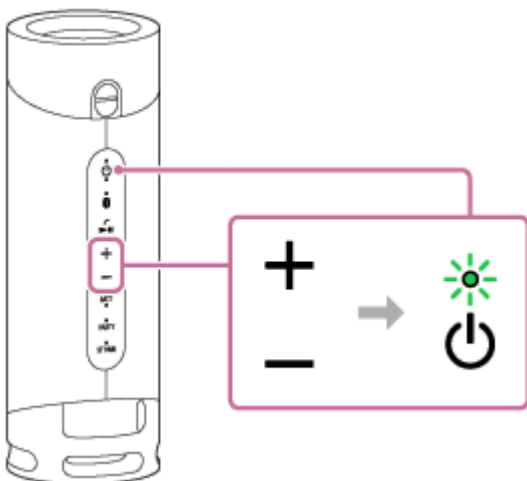

### 4 To end a call, press the (play)/ (call) button.

If you were listening to music before the call, playback will resume when the call ends. If you end a call by operating the BLUETOOTH mobile phone, playback will also resume when the call ends if you were listening to music before the call.

#### Hint

- Some BLUETOOTH mobile phones have handset use priority when receiving a call. In the case of the HFP or HSP connection, switch the call device to the speaker by operating your BLUETOOTH mobile phone.
- If the caller cannot hear or can barely hear your voice, talk more directly into the microphone of the speaker.



- The volume of music playback and calling is set independently in the speaker.

### Note

- For Apple iOS devices, the unit is compatible with iOS 10.0 or later. A BLUETOOTH connection is not available on the devices with iOS 9.x or earlier.
- When using the Stereo Pair function or Party Connect function, the sound of the phone call is output from only the speaker in which the  (BLUETOOTH) indicator lights up in blue.
- Depending on the BLUETOOTH mobile phone, playback may not pause when an incoming call arrives.
- Use a BLUETOOTH mobile phone at least 50 cm (1.6 ft) away from the speaker. Noise may result if the speaker and the BLUETOOTH mobile phone are too close.
- You cannot turn off the multi-device connection function.
- Depending on the model of your smartphone, the operation system or applications installed, some functions of hands-free calling may not be used correctly.

---

### Related Topic

- [Pairing and connecting with BLUETOOTH® devices](#)
- [Terminating the BLUETOOTH connection \(After use\)](#)
- [Making a call](#)
- [Switching the BLUETOOTH devices connected at the same time \(Multi-device-connection\)](#)

## Making a call

You can enjoy hands-free calls with a BLUETOOTH mobile phone that supports the BLUETOOTH profile HFP (Hands-free Profile) or HSP (Headset Profile) via BLUETOOTH connection.

- If your BLUETOOTH mobile phone supports both HFP and HSP, set it to HFP.
- Operations may vary depending on the BLUETOOTH mobile phone. Refer to the operating instructions supplied with the mobile phone.

### 1 Connect the speaker with a BLUETOOTH mobile phone.

When the BLUETOOTH connection is established, you hear voice guidance (BLUETOOTH connected) from the speaker and the activity of the  (BLUETOOTH) indicator changes from flashing to lit.

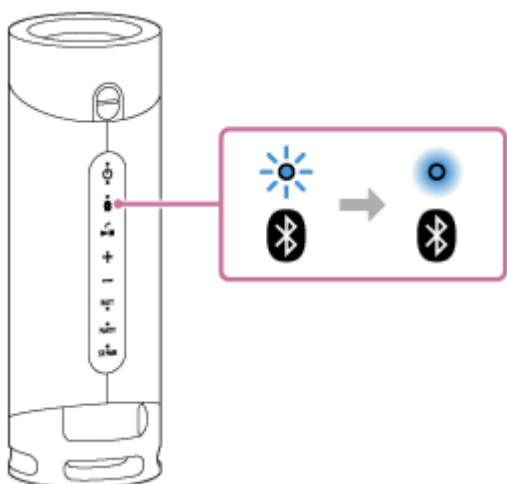

### When using the Stereo Pair function or Party Connect function

Connect to the speaker in which the  (BLUETOOTH) indicator flashes in blue. In the following steps and operations during a hands-free call, operate the speaker that is connected to the BLUETOOTH mobile phone.

### 2 Operate the BLUETOOTH mobile phone to make a call.

When you make a call, playback pauses and the dial tone is heard from the speaker. When the receiver takes the call, talk into the microphone of the speaker.

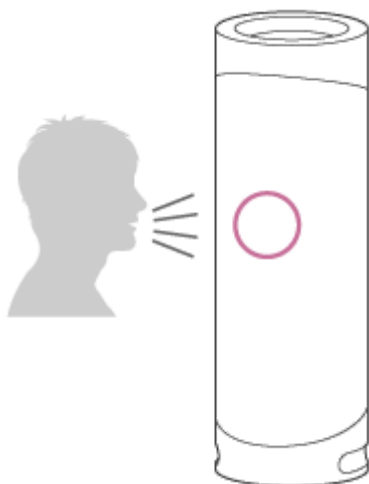

### If no dial tone is heard via the speaker

- The speaker may not be connected with a BLUETOOTH mobile phone with HFP or HSP. Check the connection status on the BLUETOOTH mobile phone.
- Switch the call device to the speaker by pressing and holding the ►|| (play)/ 📞 (call) button for about 2 seconds.
- If more than one BLUETOOTH device is connected to the speaker (Multi-device connection), you cannot make a phone call. Terminate the BLUETOOTH connection or turn off the BLUETOOTH function of the BLUETOOTH devices other than the BLUETOOTH mobile phone in use.

### 3 While the phone is ringing or a phone conversation is in progress, adjust the volume by pressing the +/- (volume) buttons on the speaker or operating the BLUETOOTH mobile phone.

When you press the +/- (volume) buttons on the speaker or adjust the volume on the BLUETOOTH mobile phone, the 🔌 (power) indicator flashes once or 3 times.

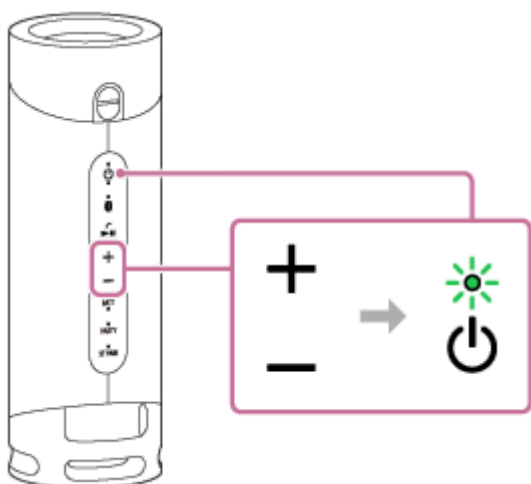

### 4 To end a call, press the ►|| (play)/ 📞 (call) button.

If you were listening to music before the call, playback will resume when the call ends. If you end a call by operating the BLUETOOTH mobile phone, playback will also resume when the call ends if you were listening to music before the call.

#### Hint

- If the caller cannot hear or can barely hear your voice, talk more directly into the microphone of the speaker.
- The volume of music playback and calling is set independently in the speaker.

#### Note

- For Apple iOS devices, the unit is compatible with iOS 10.0 or later. A BLUETOOTH connection is not available on the devices with iOS 9.x or earlier.
- When using the Stereo Pair function or Party Connect function, the sound of the phone call is output from only the speaker in which the 🔌 (BLUETOOTH) indicator lights up in blue.
- Depending on the BLUETOOTH mobile phone, playback may not pause when making a call.
- Use a BLUETOOTH mobile phone at least 50 cm (1.6 ft) away from the speaker. Noise may result if the speaker and the BLUETOOTH mobile phone are too close.
- While a multi-device connection is established, you cannot use the hands-free function. Turn off the BLUETOOTH function on the unused BLUETOOTH device(s) to disconnect the multi-device connection.

---

---

## Related Topic

- [Pairing and connecting with BLUETOOTH® devices](#)
- [Terminating the BLUETOOTH connection \(After use\)](#)
- [Receiving a call](#)
- [Switching the BLUETOOTH devices connected at the same time \(Multi-device-connection\)](#)

5-011-826-11(2) Copyright 2020 Sony Corporation

Wireless Speaker  
SRS-XB23

## What you can do with “Sony | Music Center”

“Sony | Music Center” is an app for controlling Sony audio devices which are compatible with “Sony | Music Center” using your smartphone, iPhone, etc.

For details about “Sony | Music Center,” refer to the following URL:

<https://www.sony.net/smcqa/>

### Operations that can be performed on a speaker with “Sony | Music Center”

- Playback of music files included with High-Resolution (Hi-Res) audio content which are located on a device such as a smartphone or iPhone.
- Sound quality setting and equalizer adjustment
- Built-in battery level indication
- Power Option settings (the Auto Standby function, the Bluetooth Standby function, the voice guidance associated with the remaining battery power)
- Switching BLUETOOTH codec (the BLUETOOTH audio streaming playback quality)
- Changing from monaural audio playback (factory default setting) to stereo audio playback
- Grouping with other devices (the Stereo Pair function, the Party Connect function)
- Viewing the update or version of the speaker’s software

#### Note

- What you can control with “Sony | Music Center” varies depending on the connected device. The specifications and design of the app may change without notice.
- For Apple iOS devices, the unit is compatible with iOS 10.0 or later. A BLUETOOTH connection is not available on the devices with iOS 9.x or earlier.
- Be aware that “Sony | Music Center” and “Music Center for PC” are different apps.

### Related Topic

- [Installing “Sony | Music Center”](#)
- [Charging the speaker](#)
- [Switching between monaural audio playback and stereo audio playback](#)
- [Selecting the BLUETOOTH audio streaming playback quality \(Codec\)](#)
- [Listening to music wirelessly with 2 speakers \(Stereo Pair function\)](#)
- [Enjoying wireless playback using multiple speakers \(Party Connect function\)](#)
- [Updating the pre-installed software](#)

Wireless Speaker  
SRS-XB23

## Installing “Sony | Music Center”

Install “Sony | Music Center” on your smartphone, iPhone, etc. from Google Play or the App Store.

- 1 Download “Sony | Music Center” from Google Play or the App Store and install it.



- 2 When the installation is complete, start “Sony | Music Center.”

### Note

- Be aware that “Sony | Music Center” and “Music Center for PC” are different apps.
- Be sure to use the latest version of “Sony | Music Center.” If you cannot connect the speaker and a BLUETOOTH device via a BLUETOOTH connection, or if there is a problem such as no sound being emitted, uninstall “Sony | Music Center” and try to connect via the BLUETOOTH connection again.  
For details about “Sony | Music Center,” refer to Google Play or the App Store.

### Related Topic

- [What you can do with “Sony | Music Center”](#)

Wireless Speaker  
SRS-XB23

## Using the voice assist function (Google app)

By using the Google app feature that comes with the Android smartphone, you can speak to the speaker's microphone to operate the Android smartphone.

The following shows how to use the Google app.

### 1 Select the Google app for [Assist App] in [Assist & Voice input].

On the Android smartphone, select [Settings] - [Apps & notifications] - [Advanced] - [Default apps] - [Assist & Voice input] and select the Google app for [Assist App].

The operation above is an example. For details, refer to the operating instructions supplied with the Android smartphone.

For details on the Google app, refer to the operating instructions or support website of the Android smartphone or website of Google Play.

#### Note

- The latest version of the app may be required.
- The Google app may not be activated from the speaker depending on specifications of the Android smartphone.

### 2 Connect the speaker to the Android smartphone via BLUETOOTH connection.

### 3 While the speaker is connected with the Android smartphone via BLUETOOTH connection and the Android smartphone is in standby or playing music, press and hold the (play)/ (call) button for about 3 seconds.

The Google app is activated and you will hear the start-up sound.

### 4 Make a request to the Google app through the speaker's microphone.

For details on the Google app, such as apps which work with the Google app, refer to the operating instructions supplied with the Android smartphone.

#### Note

- The Google app cannot be activated when you say "OK Google" through the speaker's microphone even when the Android smartphone's [OK Google] setting is on.

Wireless Speaker  
SRS-XB23

## Using the voice assist function (Siri)

By using the Siri function that comes with the iPhone/iPod touch, you can speak to the speaker's microphone to operate the iPhone/iPod touch.

The following shows how to use Siri.

### 1 Turn on Siri.

On the iPhone/iPod touch, select [Settings] - [Siri & Search] and enable [Listen for "Hey Siri"].

The operation above is an example. For details, refer to the operating instructions supplied with the iPhone/iPod touch.

For details on Siri, refer to the operating instructions or support website of the iPhone/iPod touch.

### 2 Connect the speaker to the iPhone/iPod touch via BLUETOOTH connection.

### 3 While the speaker is connected with the iPhone/iPod touch via BLUETOOTH connection and the iPhone/iPod touch is in standby or playing music, press and hold the (play)/ (call) button for about 3 seconds.

The Siri is activated and you will hear the start-up sound.

### 4 Make a request to Siri through the speaker's microphone.

For details on Siri, such as apps which work with Siri, refer to the operating instructions supplied with the iPhone/iPod touch.

#### Note

- For Apple iOS devices, the unit is compatible with iOS 10.0 or later. A BLUETOOTH connection is not available on the devices with iOS 9.x or earlier.
- Siri cannot be activated when you say "Hey Siri" through the speaker's microphone even when the iPhone/iPod touch's [Allow "Hey Siri"] setting is on.



## About the indicators

### CHARGE indicator (orange)

|                               |   |
|-------------------------------|---|
| Turns off                     | The speaker has completed charging.   |
| Lights up                     | The speaker is being charged.   |
| Flashes slowly                | The built-in battery is running at less than 20% and needs to be charged.   |
| Flashes 3 times and turns off | If the CHARGE indicator flashes 3 times and goes off when you turn on the speaker, the built-in battery is empty and needs to be charged. |

#### Note

- As long as the speaker is connected to an AC outlet by a USB AC adaptor (commercially available), the speaker's built-in battery is capable of charging itself even while the speaker is turned on. Depending on the usage of the speaker, however, it may take a long time before charging completes. It is recommended that you turn off the speaker before battery charging.
- Depending on the type or specifications of the USB AC adaptor, if you use the speaker at a loud volume, the remaining power of the rechargeable built-in battery may decrease or the speaker may turn off even while the speaker is connected to an AC outlet by the USB AC adaptor. This, however, does not indicate a malfunction. If such a case occurs, turn off the speaker and let the battery fully charge itself before you use the speaker.
- If the ambient temperature is extremely low or high, the built-in battery will stop charging itself for safety reasons. It may also stop charging if charging continues for a long period of time. If such a case occurs, bring the temperature up or down to an operating temperature between 5 °C and 35 °C (41 °F and 95 °F), disconnect and connect the USB cable, and then let the battery charge itself once again.

### ⏻ (power) indicator

|                           |   |
|---------------------------|---|
| Turns off                 | The speaker is turned off.  |
| Lights up (green)         | The speaker is turned on.   |
| Lights up (orange)        | The speaker is turned off. The speaker is set to the BLUETOOTH standby mode.  |
| Flashes (green or orange) | <ul style="list-style-type: none"> <li>Each time you press the +/- (volume) buttons, the indicator flashes once.</li> <li>When you operate +/- (volume) buttons and the volume is set at the lowest (0) or highest (50 for music playback/15 for phone calling) level, the indicator flashes 3 times.</li> <li>As the software update progresses, the activity of the green ⏻ (power) indicator changes (from 5 flashes to 4 flashes, a single flash, and then unlit*).</li> <li>When the speaker turns on for the first time after the software update, the indicator flashes 3 times in green to inform you that the update has completed.</li> <li>When the software update is canceled by "Sony   Music Center", the indicator flashes 4 times in green.</li> </ul> |

- When the software update ends in error, the indicator flashes 4 times in orange.

\* Depending on the situation, you may not be able to see all flashing patterns.

### Bluetooth (BLUETOOTH) indicator

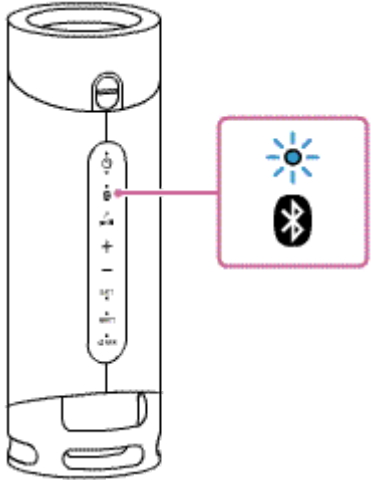
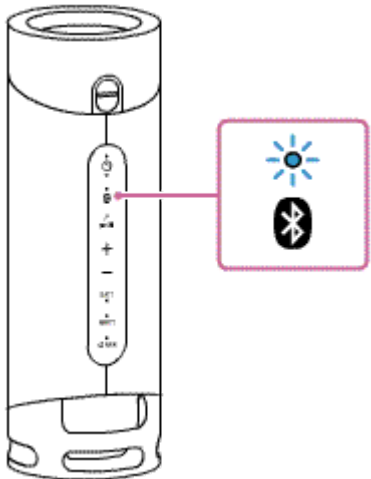
|                 |   |
|-----------------|---|
| Lights up       | The speaker is connected to a BLUETOOTH device.   |
| Double flashes  | <p>The speaker enters the pairing mode.</p>                            |
| Flashes slowly  | <p>The speaker is waiting for a BLUETOOTH device to connect to.</p>  |
| Flashes 3 times | The software has completed updating.  |

### STAMINA indicator

|           |   |
|-----------|---|
| Lights up | The sound effect is set to STAMINA mode.    |
| Turns off | The sound effect is set to EXTRA BASS mode. |

### ST PAIR (Stereo Pair) indicators

|         |   |
|---------|---|
| Flashes | <p>The speaker enters the Stereo Pair function.</p> <p>The ST PAIR (Stereo Pair) indicator flashes when the connection with Stereo Pair function fails.</p> |
|---------|---|

|           |  |
|-----------|--|
| Lights up | The Stereo Pair function is used on the speaker. |
|-----------|--|

## **PARTY (Party Connect) indicator**

|           |   |
|-----------|---|
| Flashes   | The speaker enters the Party Connect function.  |
| Lights up | The Party Connect function is used on the speaker. The indicators of all speakers connected with the Party Connect function light up. |

---

### **Related Topic**

- [Parts and controls](#)

5-011-826-11(2) Copyright 2020 Sony Corporation

## Updating the pre-installed software

When a new version of the software is released, you can update your speaker's pre-installed software by using the following methods.

By updating the software, new features will be added enabling you to experience more convenient and stable use.

**1 Connect the speaker to an AC outlet with a USB AC adaptor (commercially available).**

Software updates cannot be performed when using with the built-in battery.

**2 Turn on the speaker.**

The  (power) indicator lights up in green.

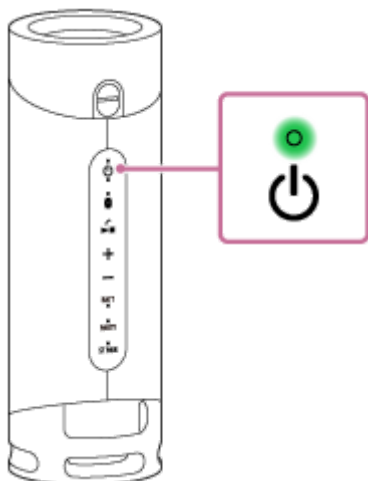

**3 Tap [Music Center] on your smartphone, iPhone, etc. to start up the application.**



Music Center



**4 Tap [SRS-XB23].**

When a new version of the software is released, an update notice is displayed on the “Sony | Music Center” screen.

**5 Follow the instructions on the screen to update.**

As the software update progresses, the activity of the green  (power) indicator changes (from 5 flashes to 4 flashes, a single flash, and then unlit).

Depending on the situation, you may not be able to see all flashing patterns.

When the speaker turns on for the first time after the software update, the  (power) and  (BLUETOOTH) indicators flash 3 times to inform you that the update has completed.

**6 Confirm the version of the speaker's software.**

On “Sony | Music Center,” tap [SRS-XB23] – [Settings] – [System].  
“XXXX” displayed under “SRS-XB23” indicates the software version.  
Latest software version: 3700 (as of July, 2020)

#### Note

- If the update fails, charge the rechargeable built-in battery until it is charged 40% or more.

---

#### Related Topic

- [Charging the speaker](#)

5-011-826-11(2) Copyright 2020 Sony Corporation

## Precautions

---

### On safety

- Refer to the Reference Guide supplied with the speaker.
- Important information such as the model name is located on the inner and outer surfaces of the cap on the rear side of the speaker.

### On placement

- To eliminate the risk of malfunctions, avoid the following locations when placing or leaving this speaker.
  - A place subject to high temperatures, such as under direct sunlight or lighting equipment, near a heat source, or in a sauna
  - Inside a vehicle with the windows closed (especially in summertime)
  - A place subject to excessive dust
  - A place subject to strong vibration
- Place this speaker on a flat, level surface. When placed on a sloped surface, the speaker may fall over or fall off the surface due to its own vibration, resulting in injuries, malfunctions, or performance degradation.
- Depending on the conditions where this speaker is placed, it may fall over or fall off the surface. Do not leave any valuables near the speaker.
- This speaker is not anti-magnetic. Keep objects susceptible to magnetism (recorded tapes, watches, cash cards and credit cards with magnetic coding, etc.) away from the speaker. When you carry around the speaker, keep this in mind as well.
- Do not use the speaker in a vehicle.

### Others

- Do not use or leave the speaker in an extremely cold or hot environment (temperature outside the range of 5 °C – 35 °C (41 °F – 95 °F)). If the speaker is used or left in outside the above range, the speaker may automatically stop to protect internal circuitry.
- Even if you do not intend to use the speaker for a long time, charge the battery to its full capacity once every 6 months to maintain its performance.
- If you have any questions or problems concerning the speaker that are not covered in this Help Guide, consult your nearest Sony dealer.

## Notes on charging

### Life span of the built-in lithium ion battery

- Even if you do not intend to use the speaker for a long time, charge the built-in battery sufficiently once every 6 months to maintain its performance.
- If the speaker is not used for a long time, it may take longer to charge the built-in battery.
- The rechargeable built-in battery has a life span. As time passes and the number of times that the built-in battery is used increases, the capacity of the rechargeable built-in battery slowly decreases. When the amount of time that the built-in battery can be used seems significantly shorter, despite having been fully charged, contact your nearest Sony dealer.
- When the amount of time that the built-in battery can be used seems significantly shorter, it could mean that the rechargeable built-in battery has expired.
- The life span of the rechargeable built-in battery differs depending on the usage, environment, and storage method.

### Caution

When the speaker detects a problem for the following causes while charging the built-in battery, the CHARGE indicator (orange) turns off even if charging is not completed.

- Ambient temperature exceeds the range of 5 °C – 35 °C (41 °F – 95 °F).
- There is a problem with the built-in battery.
- When charging to the built-in battery continues for a long time.

### Note

- Charging time varies depending on built-in battery usage conditions.
- Charge the speaker in an ambient temperature between 5 °C and 35 °C (41 °F and 95 °F).
- The speaker becomes warm during charging. This is not a malfunction.
- Avoid exposure to rapid temperature change, direct sunlight, mist, sand, dust, or mechanical shock. Also, never leave the speaker in a car parked in the sun.
- As long as the speaker is connected to an AC outlet by a USB AC adaptor (commercially available), the speaker's built-in battery is capable of charging itself even while the speaker is turned on. However, it may take a long time before charging completes depending on the usage of the speaker. It is recommended that you turn off the speaker before battery charging.
- You can charge the speaker's built-in battery by connecting the speaker to a computer that comes equipped with a USB charging port as well. However, not all the computers are tested and found compatible with this procedure and the procedure is not applicable to home-built computers.
- Do not connect the speaker to a computer for a long period of time when the computer is not connected to an AC power supply. Otherwise, the computer's battery may run out.
- In an extremely cold or hot environment, charging stops for safety. If charging takes a long time, it also makes charging of the speaker stop. To resolve these issues, disconnect the USB cable from the speaker and connect it again within an operating temperature between 5 °C and 35 °C (41 °F and 95 °F).
- At high temperature, the charging may stop or the volume may reduce to protect the battery.

- Use of a USB hub is not guaranteed for battery charging.

---

---

### Related Topic

- [Charging the speaker](#)

5-011-826-11(2) Copyright 2020 Sony Corporation



## Notes on waterproof and dust proof features

### Waterproof and dust proof performance of the speaker

The speaker, with the cap fastened securely, has a waterproof specification of IPX7\*1 as specified in “Degrees of protection against water immersion” of the IEC60529 “Ingress Protection Rating (IP Code)”\*3, and a dust proof specification of IP6X\*2 as specified in “Degrees of protection against solid foreign objects”\*3.

### Liquids that the waterproof performance specifications apply to

|                |  |
|----------------|--|
| Applicable     | fresh water, tap water, pool water, salt water   |
| Not applicable | liquids other than the above (soapy water, water with detergent or bath agents, shampoo, hot spring water, etc.) |

\*1 IPX7 equivalency: The speaker has been tested to and maintains its operability when gently submersed in water to a depth of 1 m (3.2 ft) and left for 30 minutes.

\*2 IP6X equivalency: The speaker has been tested to and continues to block dust after stirring for 8 hours in a testing device which contains dust particles that are up to 75 µm in diameter.

\*3 The supplied accessories and the connectors of this speaker (USB) are neither waterproof nor dust proof. To reduce the risk of fire or electric shocks, do not expose the speaker to water or droplets while using either or both of the connectors (USB). Do not place a vase or any other liquid-filled container on the speaker.

The waterproof and dust proof performance of the speaker is based on our measurements under the conditions herein described. Note that malfunctions as a result of water immersion or dust intrusion caused by misuse by the customer are not covered by the warranty.

### To avoid the deterioration of the waterproof and dust proof performance

Check the following and use the speaker correctly.

- The speaker passes the drop test from 1.22 m (4 ft) on plywood of 5 cm (2 in) thickness conforming to MIL-STD810H Method 516.8-Shock. However, this does not guarantee no damage, no breakdown, or waterproof and dust proof performance in all conditions. Deformation or damage from dropping the speaker or subjecting it to mechanical shock may cause deterioration of the waterproof and dust proof performance.
- This speaker does not have a design that is resistant to water pressure. Use of the speaker in a location where high water pressure is applied, such as in the shower, may cause a malfunction.
- Do not pour high-temperature water or blow hot air from a hair dryer or any other appliance on the speaker directly. Also never use the speaker in a place subject to high temperatures, such as in a sauna or near a heat source.
- Handle the cap ① with care. The cap plays a very important role in maintenance of the waterproof and dust proof performance. When using the speaker, make sure that the cap is closed completely. When closing the cap, be careful not to allow foreign objects inside. If the cap is not closed completely the waterproof and dust proof performance may deteriorate and may cause a malfunction of the speaker as a result of water or dust particles entering the speaker.

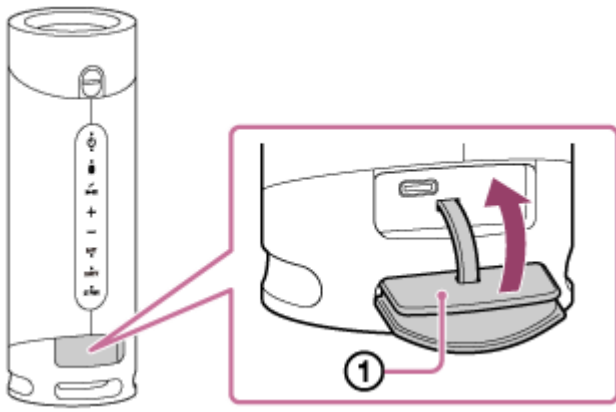

5-011-826-11(2) Copyright 2020 Sony Corporation

Wireless Speaker  
SRS-XB23

## How to care for the speaker

Although the fabric part of the speaker has water repellent treatment applied, you can use the speaker more comfortably and for a longer period of time by following the maintenance procedure below.

- When the speaker surface is soiled, immediately wash off the soil with fresh water (tap water, etc.). Leaving the soil on the surface will cause the fabric part or the passive radiator section to discolor or deteriorate, or cause the speaker to malfunction.  
Ex.
  - When salt, sand, etc. is stuck on the speaker after using it on a beach, pool side, etc.
  - When the speaker is stained with foreign substances (sunscreen, suntan oil, etc.)
- If the speaker gets wet, wipe off the moisture using a dry soft cloth immediately. In addition, dry the speaker in an airy place until no moisture remains.
- The sound quality may change if water enters the speaker or passive radiator section (①). This, however, does not indicate a malfunction. Wipe off the moisture on the speaker surface and leave the speaker on a dry soft cloth to let the water drain out from inside the speaker. Then, leave the speaker in a well-ventilated place to let it dry out.

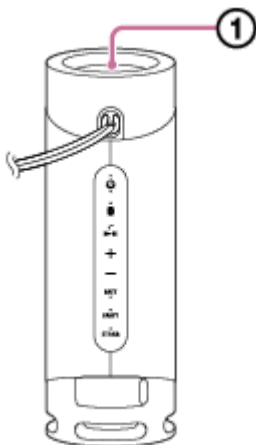

### Note

- If the surface of the speaker gets dirty, do not use detergent, thinner, benzine, alcohol, etc. to clean the speaker because it will affect the water repellent function of the fabric part of the speaker.
- Especially in cold regions, be sure to wipe off the moisture after using the speaker. Leaving moisture on its surface may cause the speaker to freeze and malfunction.
- If particles, such as sand grains, enter the fabric or other part of the speaker, remove them with care. Never use a vacuum cleaner or an equivalent for removal as it may damage the speaker or other unit.

Wireless Speaker  
SRS-XB23

## About the BLUETOOTH wireless technology

The BLUETOOTH wireless technology operates within a range of about 30 m (about 98 ft).

### Supported version and profiles of the BLUETOOTH standard

A profile is a set of functions standardized for every characteristic of BLUETOOTH devices. The speaker supports the following version and profiles of the BLUETOOTH standard.

Supported BLUETOOTH version: BLUETOOTH standard, version 5.0

Supported BLUETOOTH profiles:

- A2DP (Advanced Audio Distribution Profile): Enables transmission and reception of high-quality music contents.
- AVRCP (Audio Video Remote Control Profile): Enables volume adjustment and operations to play/pause music and skip to the beginning of the next/current track.
- HSP (Headset Profile)\*: Enables phone call making and mobile phone operations.
- HFP (Hands-free Profile)\*: Enables hands-free phone call making and mobile phone operations.

\* If the mobile phone with the BLUETOOTH function supports both HFP and HSP, use HFP (Hands-free Profile).

### Maximum communication range

Use the BLUETOOTH wireless technology between the speaker and a device that are located within 30 m (about 98 ft) from each other.

Maximum communication range may shorten under the following conditions.

- There is an obstacle such as a person, metal, or wall between the speaker and BLUETOOTH device.
- A wireless LAN device is in use near the speaker.
- A microwave oven is in use near the speaker.
- A device that generates electromagnetic radiation is in use near the speaker.

### Interference from other devices

Because BLUETOOTH devices and wireless LAN (IEEE802.11b/g) use the same frequency (2.4 GHz), microwave interference may occur and result in communication speed deterioration, noise, or invalid connection if the speaker is used near a wireless LAN device.

### Interference to other devices

Microwaves emitted from a BLUETOOTH device may affect the operation of electronic medical devices. Turn off the speaker and other BLUETOOTH devices in the following locations, as it may cause an accident.

- Where inflammable gas is present, in a hospital, train, airplane, or a gas station
- Near automatic doors or a fire alarm

#### Note

- To be able to use the BLUETOOTH function, the BLUETOOTH device to be connected requires the same profile as the speaker's. Note also that even if the same profile exists, devices may vary in function depending on their specifications.
- Due to the characteristic of BLUETOOTH wireless technology, the sound played on the speaker is slightly delayed from the sound played on the BLUETOOTH device while talking on the telephone or listening to music.
- The speaker supports security capabilities that comply with the BLUETOOTH standard to provide a secure connection when the BLUETOOTH wireless technology is used, but security may not be enough depending on the setting. Be careful when communicating using BLUETOOTH wireless technology.

- We do not take any responsibility for the leakage of information during BLUETOOTH communication.
- A device featuring the BLUETOOTH function is required to conform to the BLUETOOTH standard specified by the Bluetooth SIG, Inc. and be authenticated. Even if the connected device conforms to the above mentioned BLUETOOTH standard, some devices may not be connected or work correctly, depending on the features or specifications of the device.
- Noise or sound interruption may occur depending on the BLUETOOTH device connected with the speaker, the communication environment or the usage environment.
- A device with a built-in radio or tuner cannot be connected to the speaker via BLUETOOTH since noise may occur in broadcasts.
- Locate the speaker farther away from a TV, radio or tuner, etc. since noise may occur in broadcasts.

## License notice

---

### Notes on the License

This product contains software that Sony uses under a licensing agreement with the owner of its copyright. We are obligated to announce the contents of the agreement to customers under requirement by the owner of copyright for the software.

Please access the following URL and read the contents of the license.

<https://rd1.sony.net/help/speaker/sl/20/>

### Notice on GNU GPL/LGPL applied software

This product contains software that is subject to the following GNU General Public License (hereinafter referred to as “GPL”) or GNU Lesser General Public License (hereinafter referred to as “LGPL”). These establish that customers have the right to acquire, modify, and redistribute the source code of said software in accordance with the terms of the GPL or LGPL supplied. The source code for the above-listed software is available on the Web.

To download, please access the following URL then select the model name “SRS-XB23”.

URL: <http://oss.sony.net/Products/Linux/>

Please note that Sony cannot answer or respond to any inquiries regarding the content of the source code.

### Disclaimer regarding services offered by third parties

Services offered by third parties may be changed, suspended, or terminated without prior notice. Sony does not bear any responsibility in these sorts of situations.

## Trademarks

---

- Android, Google Play and other related marks and logos are trademarks of Google LLC.
- LDAC™ is a trademark of Sony Corporation.
- The BLUETOOTH® word mark and logos are registered trademarks owned by the Bluetooth SIG, Inc. and any use of such marks by Sony Corporation is under license.
- Apple, the Apple logo, iPhone, iPod, iPod touch, Mac, macOS and Siri are trademarks of Apple Inc., registered in the U.S. and other countries.  
App Store is a service mark of Apple Inc., registered in the U.S. and other countries.
- Use of the Made for Apple badge means that an accessory has been designed to connect specifically to the Apple product(s) identified in the badge, and has been certified by the developer to meet Apple performance standards. Apple is not responsible for the operation of this device or its compliance with safety and regulatory standards.
- USB Type-C® and USB-C® are trademarks of USB Implementers Forum.
- Microsoft and Windows are registered trademarks or trademarks of Microsoft Corporation in the United States and/or other countries.
- WALKMAN and WALKMAN logo are registered trademarks of Sony Corporation.
- Wi-Fi® is a registered trademark of Wi-Fi Alliance®.
- Other trademarks and trade names are those of their respective owners.
- ™ and ® marks are omitted in the documents.

## What can I do to solve a problem?

---

If the speaker does not function as expected, try the following steps to resolve the issue.

- Find the symptoms of the issue in this Help Guide and try any corrective actions listed.
- Charge the speaker.  
You may be able to resolve some issues by charging the built-in battery.
- Restart the speaker.
- Initialize the speaker.  
This operation restores the settings such as volume, etc. to the factory default settings, and deletes all pairing information.
- Look up information on the issue on the customer support website.
- Access the following support home pages to get support information about your speaker:
  - For customers in Americas:  
<https://www.sony.com/am/support>
  - For customers in Europe:  
<https://www.sony.eu/support>
  - For customers in China:  
<https://service.sony.com.cn>
  - For customers in other countries/regions:  
<https://www.sony-asia.com/support>

If the operations above do not work, consult your nearest Sony dealer.

---

### Related Topic

- [Restarting the speaker](#)
- [Initializing the speaker](#)



## Unable to charge the speaker

---

- When a USB AC adaptor (commercially available) is in use, make sure that the USB cable is connected securely to the speaker and the USB AC adaptor. Then, make sure that the USB AC adaptor is connected securely to an AC outlet.
- When using a USB AC adaptor (commercially available), make sure that it is capable of delivering an output current of 1.5 A or more. You can use a USB AC adaptor with an output current of 500 mA or more and less than 1.5 A as well, but it may take a very long time (10 hours or more) before charging completes. When using such a USB AC adaptor, it is recommended that you turn off the speaker before battery charging. Use of a USB AC adaptor with an output current of less than 500 mA is not guaranteed for battery charging.
- The speaker supports USB AC adaptors that are capable of delivering an output current of 1.5 A. Use of any other devices is not guaranteed for battery charging.
- You can charge the speaker's built-in battery by connecting the USB cable connected with the speaker to a computer that comes equipped with a USB charging port as well. However, not all the computers are tested and found compatible with this procedure and the procedure is not applicable to home-built computers.
- Depending on the type or specifications of the USB AC adaptor, if you use the speaker at a loud volume, the remaining power of the rechargeable built-in battery may decrease or the speaker may turn off even while the speaker is connected to an AC outlet by the USB AC adaptor. This, however, does not indicate a malfunction. If such a case occurs, turn off the speaker and let the battery fully charge itself before you use the speaker.

---

### Related Topic

- [Charging the speaker](#)
- [About the indicators](#)

## Unable to turn on the speaker or the speaker suddenly turns off

---

- The rechargeable built-in battery may be empty or running low. Connect the speaker to an AC outlet with a USB AC adaptor (commercially available).
  - Depending on the type or specifications of the USB AC adaptor, if you use the speaker at a loud volume, the remaining power of the rechargeable built-in battery may decrease or the speaker may turn off even while the speaker is connected to an AC outlet by the USB AC adaptor. This, however, does not indicate a malfunction. If such a case occurs, turn off the speaker and let the battery fully charge itself before you use the speaker.
  - The auto power off (Auto Standby) function may have activated. After about 15 minutes in certain circumstances, such as when the volume of the audio input is low, the power will automatically turn off. Raise the volume of the connected device for use, or set the auto power function to off.
- 

### Related Topic

- [Charging the speaker](#)
- [Auto power off \(Auto Standby\) function](#)

Wireless Speaker  
SRS-XB23

## No sound/Sound from only one speaker/Low sound level/Distorted sound/Humming or noise in the speaker output/No voice or low voice from callers

---

- Check that both the speaker and the connected device are turned on.
- Turn up the volume of the speaker and the connected device.
- Check that the connected device is playing.
- If you are connecting a computer to the speaker, make sure the audio output setting of the computer is set for a BLUETOOTH device.
- Check that the speaker has established BLUETOOTH connection with the BLUETOOTH device.
- Pair the speaker and the BLUETOOTH device again.
- If the connected device has an equalizer function, set it to off.
- Keep the speaker away from a microwave oven, Wi-Fi<sup>®</sup>, etc.
- Bring the BLUETOOTH device closer to the speaker. If there is any obstacle between the speaker and the BLUETOOTH device, move it out of the way.
- If the CHARGE indicator flashes slowly, turn off the speaker and charge the built-in battery sufficiently.
- A device with a built-in radio or tuner cannot be connected to the speaker via BLUETOOTH since noise may occur in broadcasts.
- Locate the speaker farther away from a TV, radio or tuner, etc. since noise may occur in broadcasts.
- When using the Stereo Pair function or Party Connect function, if any other BLUETOOTH device(s) such as a BLUETOOTH mouse or BLUETOOTH keyboard is connected to the BLUETOOTH device, terminate the connection between them.
- There are some BLUETOOTH devices that can have the wireless playback quality changed. If your device is compatible with this function, select "Priority on stable connection (SBC)" over sound quality. For details, refer to the operating instructions supplied with the device.
- Select "Priority on stable connection (SBC)" for the wireless playback quality of the speaker.
- Install the latest version of "Sony | Music Center" on the connected device. If you cannot use the latest version of "Sony | Music Center" or you cannot connect the speaker and a BLUETOOTH device via BLUETOOTH connection, uninstall "Sony | Music Center" and install it again.
- When receiving/making a phone call, check that output of the BLUETOOTH device is set for the speaker.

---

### Related Topic

- [Pairing and connecting with BLUETOOTH<sup>®</sup> devices](#)
- [Listening to music of a device via BLUETOOTH connection](#)
- [Selecting the BLUETOOTH audio streaming playback quality \(Codec\)](#)
- [About the indicators](#)

- Receiving a call
- Making a call

5-011-826-11(2) Copyright 2020 Sony Corporation

Wireless Speaker  
SRS-XB23





## Sound becomes low while in use

---

- The sound may become low in the following cases. This is not a malfunction.
  - When the built-in battery is running low and the CHARGE indicator flashes slowly, while the speaker is being powered by the built-in battery only.
  - When the rechargeable built-in battery is running low as a result of long-time use of the speaker at a loud volume even though the speaker was connected to an AC outlet by a USB AC adaptor (commercially available) or to a computer that comes equipped with a USB charging port.
  
- If the sound becomes low while in use, follow the procedure below.
  1. Turn off the speaker.
  2. Charge the built-in battery sufficiently.

## Unable to pair the speaker with a BLUETOOTH device

---

- Place the speaker and the BLUETOOTH device within 1 m (3.2 ft) of each other.
  - For Apple iOS devices, the unit is compatible with iOS 10.0 or later. A BLUETOOTH connection is not available on the devices with iOS 9.x or earlier.
  - To use the Stereo Pair function or Party Connect function, pair with the speaker in which the  (BLUETOOTH) indicator flashes in blue.
  - If the  (BLUETOOTH) indicator is not double flashing in blue, press the  (BLUETOOTH) button. You hear voice guidance (BLUETOOTH pairing) and the  (BLUETOOTH) indicator starts double flashing (pairing mode).
  - Once the speaker is initialized, an iPhone/iPod touch may not be able to connect to the speaker. In this case, delete pairing information on the iPhone/iPod touch, then pair them again.
  - Check that the BLUETOOTH device is turned on and the BLUETOOTH function is activated on the device.
  - If the speaker is not displayed on the BLUETOOTH device, turn off the device, and then turn on the device again. It may improve symptoms.
- 

### Related Topic

- [Pairing and connecting with BLUETOOTH® devices](#)
- [About the indicators](#)
- [Initializing the speaker](#)

Wireless Speaker  
SRS-XB23

## Unable to connect a BLUETOOTH device with the speaker in the Stereo Pair function

---

- After connecting 2 SRS-XB23 speakers, perform the pairing procedure between a BLUETOOTH device and the speaker in which the  (BLUETOOTH) indicator is flashing in blue.
- 

### Related Topic

- [Listening to music wirelessly with 2 speakers \(Stereo Pair function\)](#)

Wireless Speaker  
SRS-XB23

## Unable to connect with a speaker in the Party Connect function

---

- After connecting multiple speakers, perform the pairing procedure between a BLUETOOTH device and the speaker in which the  (BLUETOOTH) indicator is flashing in blue.
- 

### Related Topic

- [Enjoying wireless playback using multiple speakers \(Party Connect function\)](#)



Wireless Speaker  
SRS-XB23

## Restarting the speaker

In the event of the following, among others, press and hold the  (power) button for about 8 seconds to restart the speaker.

- You cannot operate the speaker after you turn it on.
- You cannot operate the speaker after you troubleshoot pairing issues.

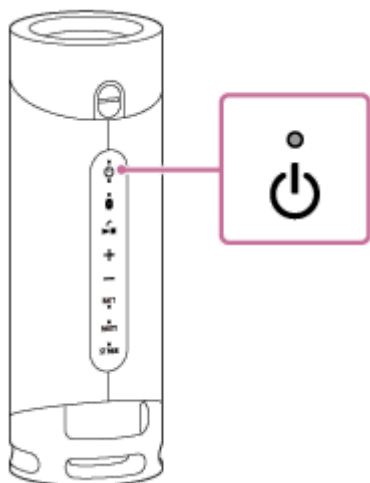

### Note

- Restarting the speaker does not delete its pairing information.
- Restarting the speaker may change its volume, function, or sound settings.

Wireless Speaker  
SRS-XB23

## Initializing the speaker

If the speaker fails to operate successfully after you restart it, initialize the speaker to resume its factory default settings. While the speaker is turned on, press and hold the - (volume) and  (BLUETOOTH) buttons until the speaker turns off (5 seconds or more).

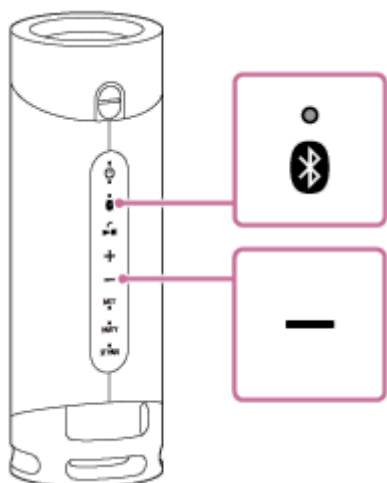

The speaker is initialized. Settings such as volume, etc., are restored to the factory default settings, and all pairing information is deleted.

### Note

- The speaker cannot be initialized while the power is off.

### Related Topic

- [Pairing and connecting with BLUETOOTH® devices](#)
- [Restarting the speaker](#)