

## Ultra HD Blu-ray™ / DVD Player

### Operating Instructions

Thank you for your purchase. Before using this player, please read this operating instructions carefully. The software of this player may be updated in the future. Please visit the following website:

[www.sony.eu/support](http://www.sony.eu/support)

Getting Started

Playback

Settings and Adjustments

Additional Information



# Contents

WARNING .....	3
PRECAUTIONS .....	4
Notes About the Discs .....	6

---

## Getting Started

Supplied Accessories .....	6
Inserting batteries into the remote control .....	6
Guide to Parts and Controls .....	7
Front panel .....	7
Rear panel .....	7
Remote .....	8
Code numbers of controllable TVs .....	9
Step 1: Connecting the Player .....	10
Connecting to your TV .....	10
Connecting to your TV via a Sound Bar/AV amplifier (receiver) .....	11
Step 2: Network Connection (Only for Software Updates and BD-Live™ Service) (Wired Only) .....	12
Step 3: Easy Setup .....	13
Home screen display .....	13

---

## Playback

Playing a Disc .....	14
Enjoying Blu-ray 3D .....	14
Enjoying 4K Ultra HD Blu-ray .....	14
Playing from a USB Device .....	14
Available Options .....	15

---

## Settings and Adjustments

Using the Settings Displays .....	17
[Software Update] .....	17
[Screen Settings] .....	17
[Audio Settings] .....	18
[BD/DVD Viewing Settings] .....	19
[Parental Control Settings] .....	20
[Music Settings] .....	20
[System Settings] .....	20
[Network Settings] .....	21
[Easy Setup] .....	21
[Resetting] .....	21

---

## Additional Information

Troubleshooting .....	22
Power .....	22
Picture .....	22
Sound .....	22
Disc .....	23
USB device .....	23
Network connection .....	23
Control for HDMI (BRAVIA Sync) .....	23
Others .....	24
Playable discs .....	25
Playable types of files .....	26
Specifications .....	28
Copyrights and Trademarks .....	29
Language code list .....	31
Parental control/area code .....	32

### Internet Connection and IP address

Technical data such as IP address [or device details] is used when this product is connected to the internet for software update or receiving third party services. For software updates, these technical data may be communicated to our update servers in order to provide you with the software update appropriate to your device. If you do not want such technical data be used at all, do not connect an internet cable.

# WARNING

To reduce the risk of fire or electric shock, do not expose this appliance to dripping or splashing, and do not place objects filled with liquids, such as vases, on the appliance.

To avoid electrical shock, do not open the cabinet. Refer servicing to qualified personnel only.

The mains lead must be changed only at a qualified service shop.

Do not expose batteries or appliances with battery-installed to excessive heat, such as sunshine and fire.

## CAUTION

Risk of explosion if the battery is replaced by an incorrect type.

The use of optical instruments with this product will increase eye hazard. As the laser beam used in this product is harmful to eyes, do not attempt to disassemble the cabinet.

Refer servicing to qualified personnel only.

CAUTION	CLASS 3R VISIBLE AND INVISIBLE LASER RADIATION WHEN OPEN, AVOID DIRECT EYE EXPOSURE.
VORSICHT	KLASSE 3R SICHTBARE UND UNSICHTBARE LASERSTRAHLUNG WENN GEÖFFNET. UNMITTELBAREN AUGENKONTAKT VERMEIDEN.
ADVARSEL	SYNLIG OG USYNLIG LASERSTRÅLING AF KLASSE 3R VED ÅBNING. UNDGÅ AT SE DIREKTE PÅ STRÅLEN.
ADVARSEL	SYNLIG OG USYNLIG LASERSTRÅLING I KLASSE 3R NÅR DEKSEL ÅPNEES. UNNGÅ DIREKTE EKSPONERING AV ØYNE.
VARNING	KLASS 3R SYNLIG OCH OSYNLIG LASERSTRÅLNING NÅR DEKSEL ÄR ÖPPNAD. UNDVIK ATT DIREKT EXPOSERAS ÖGONEN FÖR STRÅLNINGEN.
VARO!	AVATTUNA LUOKAN 3R NÄKYVÄÄ JA NÄKYVÄTÖNÄ LASERSÄTELYÄ. VÄLTÄ KATSEEN SUORAA AILUSTAMISTA.
DIKKAT	AQILGURIDA 3R SINIF GÖRÖLEBLIR VE GÖRÖLMEZ LAZER RADYASYONU YAVAR, DIREKT GÖZ TEMASINDAN KAÇININ.
警告	打开时有3R类可见和不可见激光辐射，避免眼睛受到直射的照射
注意	打開時有第3類可視及不可見雷射輻射，避免眼睛直接暴露。

This label is located on the laser protective housing inside the enclosure.

CLASS 1 LASER PRODUCT
LASER KLASSE 1
LUOKAN 1 LASERLAITE
KLASS 1 LASERAPPARAT
1类激光产品
第1類雷射產品

This appliance is classified as a CLASS 1 LASER product. The CLASS 1 LASER PRODUCT MARKING is located on the rear exterior.

## Notice for customers in the United Kingdom and Republic of Ireland

A molded plug complying with BS1363 is fitted to this equipment for your safety and convenience. Should the fuse in the plug supplied need to be replaced, a fuse of the same rating as the supplied one and approved by ASTA or BSI to BS1362, (i.e., marked with ⚡ or ⚡ mark) must be used. If the plug supplied with this equipment has a detachable fuse cover, be sure to attach the fuse cover after you change the fuse. Never use the plug without the fuse cover. If you should lose the fuse cover, please contact your nearest Sony service station.



## Disposal of waste batteries and electrical and electronic equipment (applicable in the European Union and other European countries with separate collection systems)

This symbol on the product, the battery or on the packaging indicates that the product and the battery shall not be treated as household waste. On certain batteries this symbol might be used in combination with a chemical symbol. The chemical symbols for mercury (Hg) or lead (Pb) are added if the battery contains more than 0.0005% mercury or 0.004% lead. By ensuring these products and batteries are disposed of correctly, you will help prevent potentially negative consequences for the environment and human health which could otherwise be caused by inappropriate waste handling. The recycling of the materials will help to conserve natural resources.

In case of products that for safety, performance or data integrity reasons require a permanent connection with an incorporated battery, this battery should be replaced by qualified service staff only. To ensure that the battery and the electrical and electronic equipment will be treated properly, hand over these products at end-of-life to the applicable collection point for the recycling of electrical and electronic equipment. For all other batteries, please view the section on how to remove the battery from the product safely. Hand the battery over to the applicable collection point for the recycling of waste batteries. For more detailed information about recycling of this product or battery, please contact your local Civic Office, your household waste disposal service or the shop where you purchased the product or battery.

This product has been manufactured by or on behalf of Sony Corporation.  
EU Importer: Sony Europe Limited.  
Inquiries to the EU Importer or related to product compliance in Europe should be sent to the manufacturer's authorized representative, Sony Belgium, *bijkantoor van Sony Europe Limited*, Da Vincilaan 7-D1, 1935 Zaventem, Belgium.

### Notice for the customers in Europe



Hereby, Sony Corporation declares that this equipment is in compliance with Directive 2014/53/EU.

The full text of the EU declaration of conformity is available at the following internet address:  
<http://www.compliance.sony.de/>

---

## PRECAUTIONS

- Do not install the player in an inclined position. It is designed to be operated in a horizontal position only.
  - Do not place metal objects in front of the front panel. It may limit reception of radio waves.
  - Do not place the player in a place where medical equipment is in use. It may cause a malfunction of medical instruments.
  - This player should be installed and operated with a minimum distance of at least 20 cm or more between the player and a person's body (excluding extremities: hands, wrists, feet and ankles).
  - Do not place heavy or unstable objects on the player.
  - Do not place any objects other than discs on the disc tray. Doing so may cause damage to the player or the object.
  - Take out any discs from the tray when you move the player. If you don't, the disc may be damaged.
  - Disconnect the AC power cord (mains lead) and all other cables from the player when you move the player.
  - The AC power cord (mains lead) is not disconnected from the mains as long as it is connected to the AC outlet, even if the player itself has been turned off.
  - Disconnect the player from the wall outlet if you are not going to use the player for a long time. To disconnect the AC power cord (mains lead), grasp the plug itself; never pull the cord.
  - Observe following points to prevent the AC power cord (mains lead) being damaged. Do not use the AC power cord (mains lead) if it is damaged, as doing so may result in an electric shock or fire.
    - Do not pinch the AC power cord (mains lead) between the player and wall, shelf, etc.
    - Do not put anything heavy on the AC power cord (mains lead) or pull on the AC power cord (mains lead) itself.
  - Use the supplied AC adaptor for this player, as other adaptors may cause a malfunction.
  - Do not disassemble or reverse-engineer the AC adaptor.
  - Do not confine the AC adaptor in a closed place such as a bookshelf or an AV cabinet.
  - Do not connect the AC adaptor to a traveler's electric transformer, which may generate heat and cause a malfunction.
  - Do not drop or apply shock to the AC adaptor.
- This unit operates on 220 V - 240 V AC, 50/60 Hz. Check that the unit's operating voltage is identical with your local power supply.
  - Install this unit so that the AC power cord (mains lead) can be unplugged from the wall socket immediately in the event of trouble.
  - This equipment has been tested and found to comply with the limits set out in the EMC Regulation using a connection cable shorter than 3 metres.
  - Place the player in a location with adequate ventilation to prevent heat build-up in the player.
  - To reduce the risk of fire, do not cover the ventilation opening of the appliance with newspapers, tablecloths, curtains, etc.
  - Do not expose the appliance to naked flame sources (for example, lighted candles).
  - Do not install this player in a confined space, such as a bookshelf or similar unit.
  - Do not place the player outdoors, in vehicles, on ships, or on other vessels.
  - If the player is brought directly from a cold to a warm location, or is placed in a very damp room, moisture may condense on the lenses inside the player. Should this occur, the player may not operate properly. In this case, remove the disc and leave the player turned on for about half an hour until the moisture evaporates.

- Do not turn up the volume while listening to a section with very low level inputs or no audio signals. Your ears and the speakers may be damaged when the sound level reaches the peak.
- Clean the cabinet, panel, and controls with a soft cloth. Do not use any type of abrasive pad, scouring powder or solvent such as alcohol or benzene.
- Do not use cleaning discs or disc/lens cleaners (including wet or spray types). These may cause the apparatus to malfunction.
- In the events that this player is repaired, repaired parts may be collected for reuse or recycling purposes.
- Observe the following as improper handling may damage the HDMI OUT jack and the connector.
  - Carefully align the HDMI OUT jack on the rear of the player and the HDMI connector by checking their shapes. Make sure the connector is not upside down or tilted.

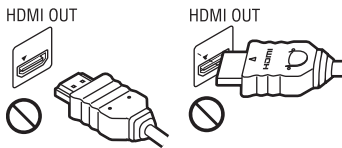

- Be sure to disconnect the HDMI cable when moving the player.



- Hold the HDMI connector straight when connecting or disconnecting the HDMI cable. Do not twist or force the HDMI connector into the HDMI OUT jack.

## On watching 3D video images

Some people may experience discomfort (such as eye strain, fatigue, or nausea) while watching 3D video images. Sony recommends that all viewers take regular breaks while watching 3D video images. The length and frequency of necessary breaks will vary from person to person. You must decide what works best. If you experience any discomfort, you should stop watching the 3D video images until the discomfort ends; consult a doctor if you believe necessary. You should also review (i) the instruction manual and/or the caution message of any other device used with, or Blu-ray Disc contents played with this product and (ii) our website ([www.sony.eu/myproducts/](http://www.sony.eu/myproducts/)) for the latest information. The vision of young children (especially those under six years old) is still under development. Consult your doctor (such as a pediatrician or eye doctor) before allowing young children to watch 3D video images. Adults should supervise young children to ensure they follow the recommendations listed above.

### IMPORTANT NOTICE

Caution: This player is capable of holding a still video image or on-screen display image on your television screen indefinitely. If you leave the still video image or on-screen display image displayed on your TV for an extended period of time you risk permanent damage to your television screen. Plasma display panel televisions and projection televisions are susceptible to this.

If you have any questions or problems concerning your player, please consult your nearest Sony dealer.

## Notes About the Discs

- To keep the disc clean, handle the disc by its edge. Do not touch the surface.  
Dust, fingerprints, or scratches on the disc may cause it to malfunction.
- Do not expose the disc to direct sunlight or heat sources such as hot air ducts, or leave it in a car parked in direct sunlight as the temperature may rise considerably inside the car.
- After playing, store the disc in its case.
- Clean the disc with a cleaning cloth. Wipe the disc from the centre out.
- Do not use solvents such as benzine, thinner, commercially available disc/lens cleaners, or anti-static spray intended for vinyl LPs.
- If you have printed the disc's label, dry the label before playing.
- Do not use the following discs.
  - A lens cleaning disc.
  - A disc that has a non-standard shape (e.g., card, heart).
  - A disc with a label or sticker on it.
  - A disc that has cellophane tape or sticker adhesive on it.
- Do not resurface the playing side of a disc to remove surface scratches.



## Getting Started

### Supplied Accessories

- AC adaptor (AC-M1215WW) (1)
- AC power cord (mains lead) (1)
- Remote commander (remote) (1)
- R03 (size AAA) batteries (2)

### Inserting batteries into the remote control

Insert two R03 (size AAA) batteries by matching the + and – ends on the batteries to the markings inside the battery compartments of the remote.

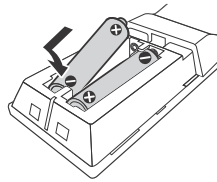

# Guide to Parts and Controls

## Front panel

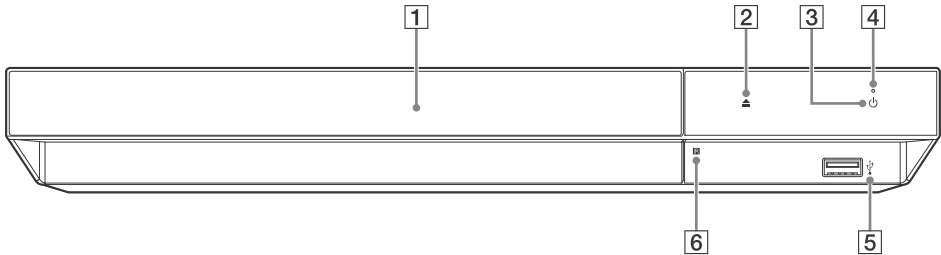

- 1 Door**
- 2 ▲ (open/close)**
- 3 ⏻ (on/standby)**  
Turns on the player, or sets to standby mode.

- 4 Power indicator**  
Lights up when the player is turned on.
- 5 USB jack**  
Connect a USB device to this jack. See page 14.
- 6 Remote sensor**

## Rear panel

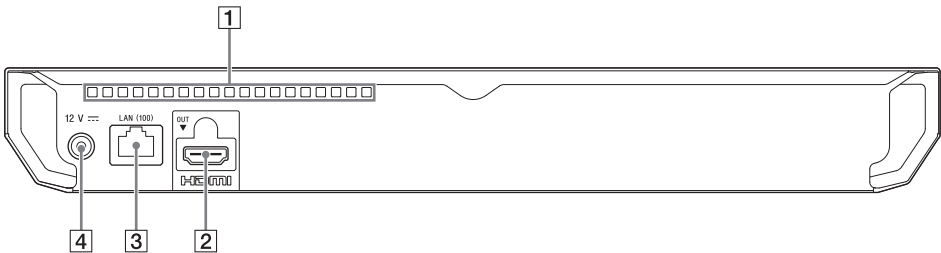

- 1 Ventilation holes**
- 2 HDMI OUT jack**  
Outputs digital video and audio signal.

- 3 LAN (100) terminal**  
Use only when updating the software or when using the BD-Live™ service.
- 4 DC IN 12 V (AC adaptor input) jack**

## Remote

The available functions of the remote are different depending on the disc or the situation.

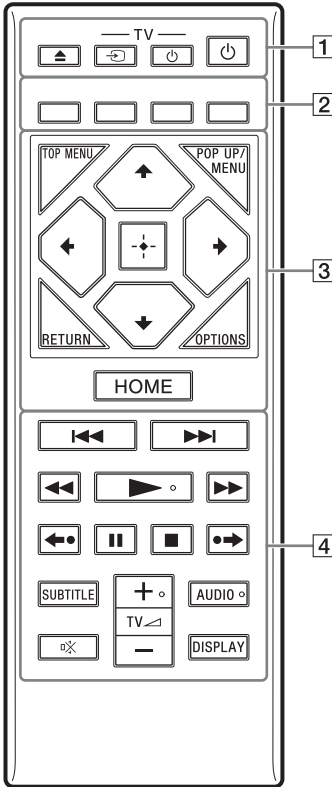

▶, TV ↙, and AUDIO buttons have a tactile dot. Use the tactile dot as a reference when operating the player.

### 1 ▲ (open/close)

Opens or closes the disc tray.

### -TV- ⇄ (TV input select)

Switches between TV and other input sources.

### -TV- ⏻ (TV on/standby)

Turns on the TV, or sets to standby mode.

### ⏻ (on/standby)

Turns on the player, or sets to standby mode.

### 2 Colour buttons (red/green/yellow/blue)

Shortcut keys for interactive functions.

### 3 TOP MENU

Opens or closes the Ultra HD Blu-ray/BD/DVD's Top Menu.

### POP UP/MENU

Opens or closes the Ultra HD Blu-ray/BD/DVD's menu.

### OPTIONS (page 15)

Displays the available options on the screen.

### RETURN

Returns to the previous display.



Moves the highlight to select a displayed item.



- ↑/↓ as a shortcut key to launch track search window and input track number during music CD playback.

- ↑/↓ as a shortcut key to rotate photo clockwise/counterclockwise by 90 degrees.

- ←/→ as a shortcut key to change still image when it is enabled to change.

### ENTER

Enters the selected item.

### HOME

Enters the player's home screen.



**4** **◀◀/▶▶ (previous/next)**

Skips to the previous/next chapter, track, or file.

**◀◀/▶▶ (fast reverse/fast forward)**

- Fast reverse/fast forward the disc when pressed during playback. The search speed changes each time you press the button.
- Plays in slow motion when pressed for more than one second in pause mode.
- Plays one frame at a time when pressed for a short time in pause mode.

**▶ (play)**

Starts or re-starts playback.

**◀•/•▶ (flash search)**

Reverses or fast-forwards slightly during Ultra HD Blu-ray/BD/DVD playback.

**|| (pause)**

Pauses or re-starts playback.

**■ (stop)**

Stops playback and remembers the stop point (resume point).

The resume point for a title/track is the last point you played or the last photo for a photo folder.

**SUBTITLE (page 19)**

Selects the subtitle language when multi-lingual subtitles are recorded on Ultra HD Blu-ray/BD/DVD.

**TV  $\triangleleft$  (volume) +/-**

Adjusts the TV volume.

**AUDIO (page 19)**

Selects the language track when multi-lingual tracks are recorded on Ultra HD Blu-ray/BD/DVD.

Selects the sound track on CDs.

**🔇 (muting)**

Turns off the TV sound temporarily.

**DISPLAY**

Displays the playback information on the screen.

**To lock the disc tray (Child Lock)**

You can lock the disc tray to avoid accidental opening of the tray.

While the player is turned on, press **■** (stop), HOME, and then TOP MENU button on the remote to lock or unlock the tray.

**Code numbers of controllable TVs**

Press and hold -TV-  $\cup$ , and then press and hold the TV manufacturer's code using the remote button for more than 2 seconds. If more than one remote button is listed, try entering them one at a time until you find one that works with your TV.

Example: If your TV is Hitachi, press and hold -TV-  $\cup$ , and then press and hold TOP MENU for more than 2 seconds.

Manufacturer	Remote Button
Sony (Default)	Colour button (red)
Philips	Colour button (green) / Colour button (yellow) / RETURN
Panasonic	Colour button (blue) / ENTER
Hitachi	TOP MENU
Sharp	↑
Toshiba	POP UP/MENU
Loewe	←
Samsung	→
LG/Goldstar	↓



This player's remote may not work with your TV, depending on the model or model year of the TV. In such a case, try this setting operation using another remote, or use the remote supplied with your TV.

# Step 1: Connecting the Player

**Do not connect the mains lead until you have made all the connections.**

## Connecting to your TV

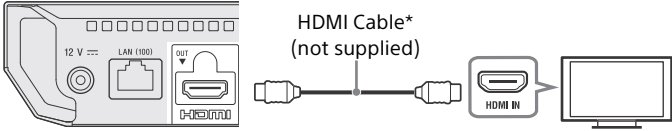

\* A Premium High Speed HDMI Cable or High Speed HDMI Cable that supports 18 Gbps bandwidth.



- To enjoy 4K Ultra HD 60p content, you need to connect the player to your 4K TV using Premium High Speed HDMI Cable or High Speed HDMI Cable that supports 18 Gbps bandwidth.
- 4K output requires a compatible 4K display which has HDCP2.2 capable HDMI input.
- If you use BRAVIA TV that supports 4K60p, set the TV's "HDMI signal format" setting to "Enhanced format". For details, refer to the TV's instruction manual.
- If a Sound Bar/AV amplifier (receiver) is directly connected to the TV, refer to the connection methods on page 11.
- If you encounter any problems or need more information, refer to "Troubleshooting" (page 22).

## Connecting to your TV via a Sound Bar/AV amplifier (receiver)

Select connection method **A** or **B** according to the input jacks on your Sound Bar/AV amplifier (receiver).

### **A** 4K Sound Bar/AV amplifier (receiver) with HDMI IN

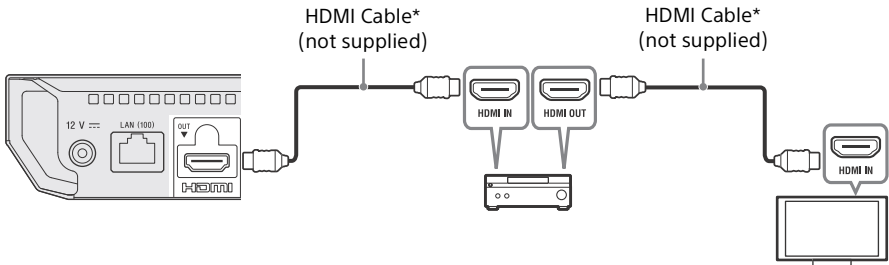

→ To enjoy Bitstream (Dolby/DTS), set [BD Secondary Audio] in [Audio Settings] (page 19).

### **B** Non-4K Sound Bar/AV amplifier (receiver) without HDMI IN

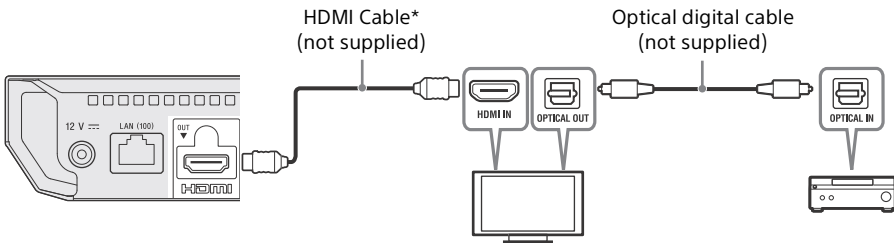

\* A Premium High Speed HDMI Cable or High Speed HDMI Cable that supports 18 Gbps bandwidth.



For details on functions that your Sound Bar/AV amplifier (receiver) supports and more information about connection methods, refer to the instruction manual supplied with the Sound Bar/AV amplifier (receiver).



If you encounter any problems or need more information, refer to "Troubleshooting" (page 22).

## Step 2: Network Connection (Only for Software Updates and BD-Live™ Service) (Wired Only)

If you are not going to connect the player to the Internet, proceed to “Step 3: Easy Setup” (page 13).

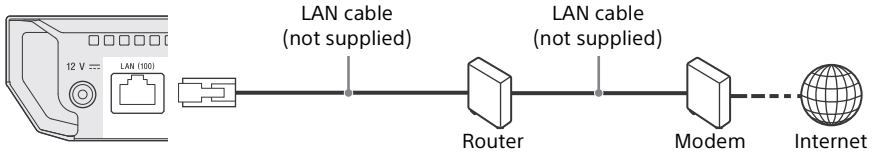

- The use of a shielded and straight interface cable (LAN cable) is recommended.
- For details on settings for network connection, see [Network Settings] (page 21).
- When the player is connected to the Internet and there is a software update, the update notification automatically appears on the screen.

## Step 3: Easy Setup

### When turned on for the first time

Wait for a short while before the player turns on and starts [Easy Setup].

- 1 Connect the supplied AC adaptor and AC power cord (mains lead) in the numeric order shown below. When removing them, do so in reverse order.

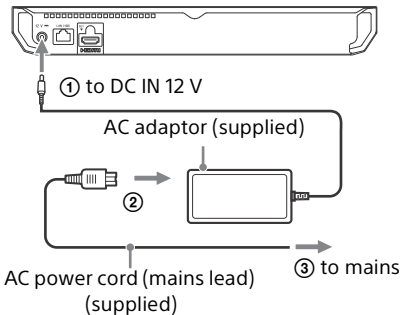

- 2 Press to turn on the player. Power indicator lights up.

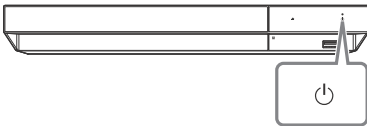

- 3 Turn on the TV and press -TV- button on the remote to set the input selector. This will show the signal from the player on your TV screen.
- 4 Perform [Easy Setup].  
Follow the on-screen instructions to make the basic settings using /// and press ENTER on the remote.

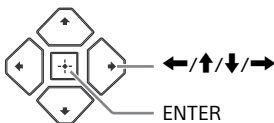

- When [Easy Setup] is complete, the player will automatically find the available network.
- If there is no output or black screen appears, refer to "Troubleshooting" (page 22).

## Home screen display

The home screen appears when you press HOME. Select an application using /, and press ENTER.

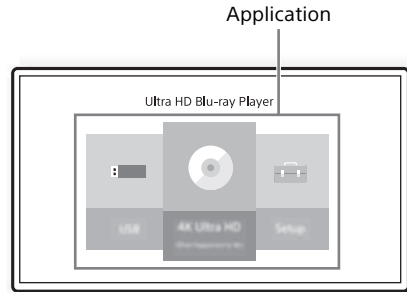

The following three applications are displayed on the home screen.

- **(Disc):**  
Plays a disc.

- **[USB device]:**  
Plays content from a USB device.

- **[Setup]:**  
Adjusts the player's settings.

## Playback

### Playing a Disc

You can play Ultra HD Blu-ray discs, BDs, DVDs and CDs. For "Playable discs", see page 25.

- 1 Press **▲** (open/close), and place a disc on the disc tray.  
Place the disc's side with character or image facing up.  
For double-sided discs, place the side you want to play facing down.

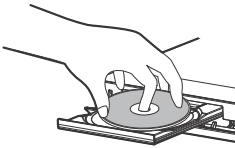

- 2 Press **▲** (open/close) to close the disc tray.  
Playback starts.  
If playback does not start automatically, select the [Video], [Music], or [Photo] category in **⦿** (Disc), and press **ENTER** or **▶** (play).



**⦿** (Mixed disc) contains data contents. Press **OPTIONS** on the remote and select [Data Contents] to display any available contents.

### Enjoying Blu-ray 3D

- 1 Prepare for Blu-ray 3D disc playback.
  - Connect the player to your 3D-compatible devices using a High Speed HDMI Cable.
  - Set [3D Output Setting] and [TV Screen Size Setting for 3D] in [Screen Settings] (page 18).
- 2 Insert a Blu-ray 3D disc.  
The operation method differs depending on the disc. Refer to the instruction manual supplied with the disc.



Also refer to the instruction manuals supplied with your TV and the connected device.

### Enjoying 4K Ultra HD Blu-ray

- 1 Prepare for 4K Ultra HD Blu-ray playback.
  - Connect the player to your 4K TV using a Premium High Speed HDMI Cable.
  - To view 4K Ultra HD 60p content, make sure that the proper setting is selected in HDMI settings on your TV.
  - If you use BRAVIA TV that supports 4K60p, set the TV's "HDMI signal format" setting to "Enhanced format".
- 2 Insert a 4K Ultra HD Blu-ray disc.  
The operation method differs depending on the disc. Refer to the instruction manual supplied with the disc.



When playing a 4K Ultra HD Blu-ray disc with no disc key, it may require network connection depending on the network environment and official key server (Studio).

### Playing from a USB Device

For "Playable types of files", see page 26.

- 1 Connect the USB device to the USB jack on the player.



- 2 On the home screen, select **■** [USB device] using **←/→**, and press **ENTER**.
- 3 Select the [Video], [Music], or [Photo] category using **↑/↓**, and press **ENTER**.



To avoid data corruption or damage to the USB device, turn off the player when connecting or removing the USB device.

## Available Options

Various settings and playback operations are available by pressing **OPTIONS**. The available items differ depending on the situation.

### Common options

- **[Repeat Setting]<sup>\*1</sup>**: Sets the repeat mode.
- **[Play]/[Stop]**: Starts or stops the playback.
- **[Play from start]**: Plays the item from the beginning.

### Video only

- **[3D Output Setting]**: Sets whether or not to output 3D video automatically.
- **[A/V SYNC]**: Adjusts the gap between picture and sound, by delaying the sound output in relation to the picture output (0 to 120 milliseconds).
- **[HDR Conversion]<sup>\*2</sup>**: Converts High Dynamic Range (HDR) signal to Standard Dynamic Range (SDR) signal when the player is connected to a TV or a Projector that does not support HDR input. A picture is more similar to HDR when larger value is selected, but lowers overall brightness.
- **[Video Settings]<sup>\*3</sup>**:
  - [Picture Quality Mode]: Selects the picture settings for different lighting environments.
    - [Direct]
    - [Brighter Room]<sup>\*4</sup>
    - [Theatre Room]<sup>\*4</sup>
    - [Auto]: Noise reduction (NR) mode control depends on media and contents.
    - [Custom1]/[Custom2]
      - [FNR]: Reduces the random noise appearing in the picture.
      - [BNR]: Reduces the mosaic-like block noise in the picture.
      - [MNR]: Reduces minor noise around the picture outlines (mosquito noise).
      - [Contrast]
      - [Brightness]
      - [Colour]
      - [Hue]

- **[Pause]**: Pauses the playback.
- **[Top Menu]**: Displays the Ultra HD Blu-ray/BD/DVD's Top Menu.
- **[Menu]/[Popup Menu]**: Displays the Ultra HD Blu-ray/BD's Pop-up Menu or DVD's menu.
- **[Title Search]**: Searches for a title on Ultra HD Blu-ray/BD/DVD VIDEO and starts playback from the beginning.
- **[Chapter Search]**: Searches for a chapter and starts playback from the beginning.
- **[Audio]**: Switches the language track when multilingual tracks are recorded on Ultra HD Blu-ray/BD/DVD. Selects the sound track on CDs.
- **[Subtitle]**: Switches the subtitle language when multilingual subtitles are recorded on Ultra HD Blu-ray/BD/DVD.
- **[Angle]**: Switches to other viewing angles when multi-angles are recorded on Ultra HD Blu-ray/BD/DVD.
- **[Number Entry]**: Selects the number by using **←/↑/↓/→** key on the remote.

### Music only

- **[Track Search]**: Searches the track number during music CD playback.
- **[Add Slideshow BGM]**: Registers music files in the USB memory as slideshow background music (BGM).
- **[Shuffle Setting]**: Set to [On] to playback music files in randomised order.

### Photo only

- **[Slideshow Speed]**: Changes the slideshow speed.
- **[Slideshow Effect]**: Sets the effect for slideshows.
- **[Slideshow BGM]**:
  - [Off]: Turns off the function.
  - [My Music from USB]: Sets the music files registered in [Add Slideshow BGM].
  - [Play from Music CD]: Sets the tracks in CD-DAs.
- **[2D Playback]<sup>\*5</sup>**: Sets playback to 2D image.
- **[Change Display]**: Switches between [Grid View] and [List View].
- **[View Image]**: Displays the selected photo.

- **[Slideshow]:** Plays a slideshow.
- **[Rotate Left]:** Rotates the photo counterclockwise by 90 degrees.
- **[Rotate Right]:** Rotates the photo clockwise by 90 degrees.





- \*1 [Repeat Setting] is not available during BDJ titles playback or HDMV interactive title.
- \*2 [HDR Conversion] is only available during HDR video playback, when your display device is not compatible with HDR display, or when [HDR Output] in [Screen Settings] is set to [Off].
- \*3 [Video Settings] output may not be significantly observed with normal eyes.
- \*4 [Brighter Room] and [Theatre Room] are not available during HDR video playback.
- \*5 [2D Playback] is only available during 3D photo playback.



## Using the Settings Displays

Select  [Setup] on the home screen when you need to change the settings of the player.

The default settings are underlined.

- 1 On the home screen, select  [Setup] using , and press ENTER.
- 2 Select the setup category icon using , and press ENTER.

## [Software Update]

### ■ [Update via Internet]

Updates the player's software using available network. Make sure that the network is connected to the Internet. See "Step 2: Network Connection (Only for Software Updates and BD-Live™ Service) (Wired Only)" (page 12).



If an update notification screen appears when you turn the power on while this player is connected to the Internet, follow the on-screen instructions to update it.

### ■ [Update via USB Memory]

Updates the player's software using USB memory. Create a folder named "UPDATE" and all the update files must be stored in this folder. The player can recognise up to 500 files/folders in a single layer including the update files/folders.



- We recommend performing the software update every 2 months or so.
- If your network condition is poor, visit [www.sony.eu/support](http://www.sony.eu/support) to download the latest software version and update via USB memory. You can also get information about update functions from the website.

## [Screen Settings]

### ■ [HDR Output]

[Auto]: Outputs HDR signal depending on contents and HDMI-SINK capability. Conversion function is applied when content is HDR and HDMI-SINK does not support HDR. [Off]: Always output SDR.

### ■ [Display Type]

[TV]: Select this when the player is connected to TV.

[Projector]: Select this when the player is connected to Projector.



[HDR Conversion] will be adjusted according to the display type you select. Even though same setting value of [HDR Conversion] is selected, dynamic range of picture is different.

### ■ [Output Video Resolution]

Normally select [Auto]. When the resolution is lower than the SD resolution, it is scaled up to the SD resolution.

### ■ [24p Output]

Outputs 24p video signals only when you connect a 24p-compatible TV via an HDMI connection and the [Output Video Resolution] is set to [Auto], [1080p] or [4K].

### [Ultra HD Blu-ray/BD-ROM]

[Auto]: Outputs 24 Hz video signals only when you connect a 24p-compatible TV using the HDMI OUT jack.

[On]: Turns on the function.

[Off]: Select this when your TV is not compatible with 24p video signals.

### [DVD-ROM]

[Auto]: Outputs 24 Hz video signals only when you connect a 24p-compatible TV using the HDMI OUT jack.

[Off]: Select this when your TV is not compatible with 24p video signals.

### [Data content]

This function is available for playback contents stored in USB memory or data disc.

[Auto]: Outputs 24 Hz video signals only when you connect a 24p-compatible TV using the HDMI OUT jack.

[Off]: Select this when your TV is not compatible with 24p video signals.

### ■ [4K Upscale Setting]

[Auto1]: Outputs 2K (1920 × 1080) video signals when connected to Sony 4K-compatible equipment for video playback. The signals are upconverted to 4K video signals by the equipment. For photo playback, this player outputs 4K video signals to the equipment.

Outputs 4K video signals when connected to a non-Sony 4K-compatible equipment.

This setting does not work for 3D video image playback.

[Auto2]: Automatically outputs 4K video signals when you connect a 4K-compatible equipment.

[Off]: Turns off the function.



If your Sony equipment is not detected when [Auto1] is selected, the setting will have the same effect as [Auto2] setting.

### ■ [YCbCr/RGB (HDMI)]

[Auto]: Automatically detects the connected TV type, and switches to the matching colour setting.

[YCbCr (4:2:2)]: Outputs YCbCr 4:2:2 video signals.

[YCbCr (4:4:4)]: Outputs YCbCr 4:4:4 video signals.

[RGB]: Outputs RGB video signals.

### ■ [HDMI Deep Colour Output]

[Auto]: Outputs 12bit/10bit video signals when the connected TV is compatible with Deep Colour.

[Off]: Select this when the picture is unstable or colours appear unnatural.

### ■ [3D Output Setting]

[Auto]: Normally select this.

[Off]: Select this to display all content in 2D or to enjoy 4K output using 3D content.

### ■ [TV Screen Size Setting for 3D]

Sets the screen size of your 3D-compatible TV.

### ■ [TV Type]

[16:9]: Select this when connecting to a wide-screen TV or a TV with a wide mode function.

[4:3]: Select this when connecting to a 4:3 screen TV without a wide mode function.

### ■ [Screen Format]

[Full]: Select this when connecting to a TV with a wide mode function. Displays a 4:3 screen picture in 16:9 aspect ratio even on a wide-screen TV.

[Normal]: Changes the picture size to fit the screen size with the original picture aspect ratio.

### ■ [DVD Aspect Ratio]

[Letter Box]: Displays a wide picture with black bands on the top and bottom.

[Pan & Scan]: Displays a full-height picture on the entire screen, with trimmed sides.

### ■ [Cinema Conversion Mode]

[Auto]: Normally select this. The player automatically detects whether the material is video-based or film-based, and switches to the appropriate conversion method.

[Video]: The conversion method suited for video-based material will always be selected regardless of the material.

### ■ [Pause Mode]

[Auto]: Normally select this. Dynamic moving pictures appear without blurring.

[Frame]: Displays static pictures at high resolution.



## [Audio Settings]

### ■ [Digital Audio Output]

[Auto]: Normally select this. Outputs audio signals according to the status of the connected devices.

[PCM]: Outputs PCM signals from the HDMI OUT jack. Select this if there is no output from the connected device.

### ■ [DSD Output Mode]

[Auto]: Outputs DSD signal from HDMI OUT jack when playing Super Audio CD & DSD format file (if the connected device also supports DSD).

Outputs LPCM signal from HDMI OUT jack when playing Super Audio CD & DSD format file (if the connected device does not support DSD).

[Off]: Outputs PCM signals from HDMI OUT jack when playing Super Audio CD and DSD format file.

**■ [BD Secondary Audio]**

[On]: Outputs the audio obtained by mixing the interactive and secondary audio to the primary audio.

[Off]: Outputs the primary audio only. Select this to output Bitstream (Dolby/DTS) signals to a Sound Bar/AV amplifier (receiver).



To enjoy Bitstream (Dolby/DTS) signals, set [BD Secondary Audio] to [Off] and [Digital Audio Output] to [Auto].

**■ [Digital Music Enhancer]**

[On]: Set the sound effect when playing content from a USB device.

[Off]/[Sound Bar Mode]: Turns off the function.

**■ [Audio DRC]**

[Auto]: Performs playback at the dynamic range specified by the disc (BD-ROM only). Other discs are played back at the [On] level.

[On]: Performs playback at a standard compression level.

[Off]: No compression works. A more dynamic sound is produced.

**■ [Downmix]**

[Surround]: Outputs audio signals with surround effects. Select this when connecting an audio device that supports Dolby Surround (Pro Logic) or DTS Neo:6.

[Stereo]: Outputs audio signals without surround effects. Select this when connecting an audio device that does not support Dolby Surround (Pro Logic) or DTS Neo:6.

## [BD/DVD Viewing Settings]

**■ [BD/DVD Menu Language]**

Selects the default menu language for Ultra HD Blu-ray/BD/DVD VIDEO.

Select [Select Language Code], and enter the code for your language, referring to "Language code list" (page 31).

**■ [Audio Language]**

Selects the default audio language for Ultra HD Blu-ray/BD/DVD VIDEO.

When you select [Original], the language given priority in the disc is selected.

Select [Select Language Code], and enter the code for your language, referring to "Language code list" (page 31).

**■ [Subtitle Language]**

Selects the default subtitle language for Ultra HD Blu-ray/BD/DVD VIDEO.

Select [Select Language Code], and enter the code for your language, referring to "Language code list" (page 31).

**■ [BD Hybrid Disc Playback Layer]**

[BD]: Plays BD layer.

[DVD/CD]: Plays DVD or CD layer.

**■ [BD Internet Connection]**

[Allow]: Allows Internet connection from BD contents.

[Do not allow]: Prohibits Internet connection from BD contents.

**■ [Delete BD Data]**

Deletes data in the USB memory.

All data stored in the buda folder will be erased.

---

## [Parental Control Settings]

### ■ [Password]

Sets or changes the password for the Parental Control function. A password allows you to set a restriction on Ultra HD Blu-ray/BD/DVD VIDEO playback. If necessary, you can differentiate the restriction levels for Ultra HD Blu-ray/BD/DVD VIDEO.

### ■ [Parental Control Area Code]

Playback of some Ultra HD Blu-ray/BD/DVD VIDEO can be limited according to the geographic area. Scenes may be blocked or replaced with different scenes. Follow the on-screen instructions and enter your four-digit password.

### ■ [BD Parental Control] / [DVD Parental Control]

By setting Parental Control, scenes can be blocked or replaced with different scenes. Follow the on-screen instructions and enter your four-digit password.

---

## [Music Settings]

### ■ [Super Audio CD Playback Layer]

[Super Audio CD]: Plays the Super Audio CD layer.

[CD]: Plays the CD layer.

### ■ [Super Audio CD Playback Channels]

[DSD 2ch]: Plays the 2ch area.

[DSD Multi]: Plays the multi-channel area.

---

## [System Settings]

### ■ [OSD Language]

Selects on-screen display language for your player.

### ■ [System Sound]

[On]: Activates the beep sound for operation on the home screen.

[Off]: Turns off the function.

### ■ [HDMI Settings]

By connecting Sony components that are compatible with HDMI functions with a High Speed HDMI Cable, operation is simplified.

### [Control for HDMI]

[On]: The following BRAVIA Sync features are available:

- One-Touch Play
- System Power-Off
- Language Follow

[Off]: Turns off the function.



For details, refer to the instruction manual supplied with the TV or components. To enable the BRAVIA Sync features, connect your TV via the HDMI OUT jack.

### [Linked to TV-off]

[Valid]: Automatically turns off the player when the connected TV enters standby mode (BRAVIA Sync).

[Invalid]: Turns off the function.

### ■ [Quick Start Mode]

[On]: Shortens the startup time when turning on the player.

[Off]: Reduces standby power consumption.

### ■ [Auto Standby]

[On]: Automatically returns to standby mode if no button is pressed for more than 20 minutes.

[Off]: Turns off the function.

### ■ [Auto Display]

[On]: Automatically displays information on the screen when changing the viewing titles, picture modes, audio signals, etc.

[Off]: Displays information only when you press DISPLAY.

### ■ [Software Update Notification]

[On]: Sets the player to inform you of newer software version information (page 17).

[Off]: Turns off the function.

### ■ [System Information]

Displays the player's software version information and the MAC address.

### ■ [Software License Information]

Displays information about the Software License.

---

## [Network Settings]

### ■ [Internet Settings]

Connect the player to the network using a LAN cable beforehand. For details, see “Step 2: Network Connection (Only for Software Updates and BD-Live™ Service) (Wired Only)” (page 12).



For further details, visit the following website and check the FAQ contents:  
[www.sony.eu/support](http://www.sony.eu/support)

### ■ [Network Connection Status]

Displays the current network status.

### ■ [Network Connection Diagnostics]

Checks for the proper network connection by running the network diagnostics.

---

## [Easy Setup]

1-2-3

See “Step 3: Easy Setup” (page 13).

---

## [Resetting]

### ■ [Reset to Factory Default Settings]

Resets the player settings to the factory default by selecting the group of settings. All the settings within the group will be reset.

### ■ [Initialise Personal Information]

Erases your personal information stored in the player.



If you dispose, transfer or resell this unit, please delete all Personal Information for security purposes.

## Troubleshooting

If a problem occurs while operating the player, use this troubleshooting guide to help remedy the problem before requesting repairs. If the problem persists, consult your nearest Sony dealer.

### Power

**The player does not turn on even when you press  on the remote or the player.**

- Turn off the player and disconnect the AC power cord (mains lead). Wait for more than 30 seconds, then reconnect the AC power cord (mains lead) and turn on the player.

### Picture

**No picture or the picture is not output correctly.**

- Check that all the cables are securely connected (page 10).
- Switch the input selector on your TV to display the signal from the player.
- Reset the [Output Video Resolution] to the lowest resolution by pressing  (stop), HOME, and then POP UP/MENU button on the remote.
- Try the following: ①Turn the player off and on again. ②Turn the connected equipment off and on again. ③Disconnect and then reconnect the HDMI cable.
- The HDMI OUT jack is connected to a DVI device that does not support copyright protection technology.
- Check the [Output Video Resolution] settings in [Screen Settings] (page 17).
- For Ultra HD Blu-ray/BD-ROM/DVD-ROM/Data content, check the [24p Output] settings in [Screen Settings] (page 17).
- For 4K output, please make sure that the player is connected to 4K display that supports HDCP2.2 capable HDMI input using Premium High Speed HDMI Cable or High Speed HDMI Cable that supports 18 Gbps bandwidth (page 10).

**The display language on the screen switches automatically when connected to the HDMI OUT jack.**

- When [Control for HDMI] in [HDMI Settings] is set to [On] (page 20), the display language on the screen automatically switches according to the language setting of the connected TV (if you change the setting on your TV, etc.).

### Sound

**No sound or the sound is not output correctly.**

- Check that all the cables are securely connected (page 10).
- Switch the input selector on your Sound Bar/AV amplifier (receiver) so that the audio signals of the player are output from your Sound Bar/AV amplifier (receiver).
- If the audio signal does not come through the HDMI OUT jack, check the audio settings (page 18).
- For HDMI connections, try the following:  
①Turn the player off and on again. ②Turn the connected equipment off and on again. ③Disconnect and then reconnect the HDMI cable.
- For HDMI connections, if the player is connected to a TV through a Sound Bar/AV amplifier (receiver), try connecting the HDMI cable directly to the TV. Also refer to the instruction manual supplied with the Sound Bar/AV amplifier (receiver).
- The HDMI OUT jack is connected to a DVI device (DVI jacks do not accept audio signals).
- The device connected to the HDMI OUT jack does not support the audio format of the player. Check the audio settings (page 18).

**The HD Audio (Dolby Digital Plus, Dolby TrueHD, DTS-HD High Resolution Audio, DTS-HD Master Audio, Dolby Atmos<sup>\*1</sup> and DTS:X<sup>\*2</sup>) is not output by bitstream.**

- Set [BD Secondary Audio] in [Audio Settings] to [Off] (page 19).
- Check that the Sound Bar/AV amplifier (receiver) is compatible with each HD Audio format.

<sup>\*1</sup> Dolby Atmos is a trademark of Dolby Laboratories.

<sup>\*2</sup> DTS:X is a registered trademark and/or trademark of DTS, Inc. in the United States and/or other countries.

**The interactive audio is not output.**

- Set [BD Secondary Audio] in [Audio Settings] to [On] (page 19).

**Message Code 3 [Audio outputs temporarily muted. Do not adjust the playback volume. The content being played is protected by Cinavia and is not authorized for playback on this device. For more information, see <http://www.cinavia.com>. Message Code 3.] appears on the screen when playing a disc.**

- The audio track of the video that you are playing contains a Cinavia code indicating that it is an unauthorised copy of professionally-produced content (page 30).

## Disc

**The disc does not play.**

- The disc is dirty or skewed.
- The disc is upside down. Insert the disc with the playback side facing down.
- The disc has a format that cannot be played back by this player (page 25).
- The player cannot play a recorded disc that is not correctly finalised or the disc is not in Mastered disc format.
- The region code on the BD/DVD does not match the player.

## USB device

**The player does not detect a USB device connected to the player.**

- Make sure that the USB device is securely connected to the USB jack.
- Check if the USB device or the USB cable is damaged.
- Check if the USB device is turned on.
- If the USB device is connected via a USB hub, connect the USB device directly to the player.

## Network connection

**The player cannot connect to the network.**

- Check the network connection (page 12) and the network settings (page 21).

**The message [A new software version is available. Please go to the "Setup" section of the menu and select "Software Update" to perform the update.] appears on the screen when turning the player on.**

- See [Software Update] (page 17) to update the player to a newer software version.

## Control for HDMI (BRAVIA Sync)

**The [Control for HDMI] function does not work (BRAVIA Sync).**

- Check that your TV is connected via the HDMI OUT jack.
- Check that [Control for HDMI] in [HDMI Settings] is set to [On] (page 20).
- If you change the HDMI connection, turn the player off and on again.
- If power failure occurs, set [Control for HDMI] in [HDMI Settings] to [Off], then set [Control for HDMI] in [HDMI Settings] to [On] (page 20).
- Check the following and refer to the instruction manual supplied with the component.
  - the connected component is compatible with the [Control for HDMI] function.
  - the connected component's setting for the [Control for HDMI] function is correct.
- When you connect the player to a TV through a Sound Bar/AV amplifier (receiver),
  - if the Sound Bar/AV amplifier (receiver) is not compatible with the [Control for HDMI] function, you may be unable to control the TV from the player.
  - if you change the HDMI connection, disconnect and reconnect the AC power cord (mains lead), or a power failure occurs, try the following:
    - ① Switch the input selector of the Sound Bar/AV amplifier (receiver) so that the picture from the player appears on the TV screen.
    - ② Set [Control for HDMI] in [HDMI Settings] to [Off], then set [Control for HDMI] in [HDMI Settings] to [On] (page 20). Refer to the instruction manual supplied with the Sound Bar/AV amplifier (receiver).

**The System Power-Off function does not work (BRAVIA Sync).**

- Check that [Control for HDMI] and [Linked to TV-off] in [HDMI Settings] are set to [On] and [Valid] (page 20).

**Others**

**Playback does not start from the beginning of content.**

- Press OPTIONS, and select [Play from start].



**Playback does not start from the resume point where you last stopped playing.**

- The resume point may be cleared from memory depending on the disc when
  - you open the disc tray.
  - you disconnect the USB device.
  - you play other content.
  - you turn off the player.

**Message Code 1 [Playback stopped. The content being played is protected by Cinavia and is not authorized for playback on this device. For more information, see <http://www.cinavia.com>. Message Code 1.] appears on the screen when playing a disc.**

- The audio track of the video that you are playing contains a Cinavia code indicating it was intended for presentation using professional equipment only and is not authorised for playback by consumers (page 30).

**The disc tray does not open and you cannot remove the disc even after you press  (open/close).**

- While the player is turned on, press  (stop), HOME, and then TOP MENU button on the remote to unlock the tray and disable the Child Lock (page 9).
- Try the following: ① Turn the player off, and disconnect the AC power cord (mains lead). ② Reconnect the AC power cord (mains lead) while pressing down  (open/close) on the player. ③ Keep pressing down  (open/close) on the player until the tray opens. ④ Remove the disc.

**The message [[EJECT] Key is currently unavailable.] appears on the screen after  (open/close) is pressed.**

- Contact your nearest Sony dealer or local authorised Sony service facility.

**The player does not respond to any button.**

- Moisture has condensed inside the player (page 4).

**About software update**

- If your network condition is poor, visit [www.sony.eu/support](http://www.sony.eu/support) to download the latest software version and update via USB memory. You can also get information about update functions from the website.



## Playable discs

<b>Blu-ray Disc</b> <sup>*1</sup>	Ultra HD Blu-ray, BD-ROM, BD-R <sup>*2</sup> /BD-RE <sup>*2</sup>
<b>DVD</b> <sup>*3</sup>	DVD-ROM, DVD-R/ DVD-RW, DVD+R/DVD+RW
<b>CD</b> <sup>*3</sup>	CD-DA (Music CD), CD-ROM, CD-R/CD-RW, Super Audio CD

<sup>\*1</sup> Since the Blu-ray Disc specifications are new and evolving, some discs may not be playable depending on the disc type and the version. The audio output differs depending on the source, connected output jack, and selected audio settings.

<sup>\*2</sup> BD-RE: Ver.2.1, BD-R: Ver.1.1, 1.2, 1.3 including organic pigment type BD-R (LTH type). The BD-Rs recorded on a PC cannot be played if postscripts are recordable.

<sup>\*3</sup> A CD or DVD disc will not play if it has not been correctly finalised or the disc is not in Mastered disc format. For more information, refer to the instruction manual supplied with the recording device.

### Discs that cannot be played

- BDs with cartridge
- BDXLs
- DVD-RAMs
- HD DVDs
- PHOTO CDs
- Data part of CD-Extras
- Super VCDs
- DVD AUDIO
- Audio material side on DualDiscs

### Note on Discs

This product is designed to playback discs that conform to the Compact Disc (CD) standard. DualDiscs and some of the music discs encoded with copyright protection technologies do not conform to the Compact Disc (CD) standard, therefore, these discs may not be playable by this product.

### Note on playback operations of Ultra HD Blu-ray/BD/DVD

Some playback operations of Ultra HD Blu-ray/BD/DVD may be intentionally set by software producers. Since this player plays Ultra HD Blu-ray/BD/DVD according to the disc contents the software producers designed, some playback features may not be available.

### Note about double-layer Ultra HD Blu-ray/BD/ DVD and triple-layer Ultra HD Blu-ray

The playback pictures and sound may be momentarily interrupted when the layers switch.

### Region code (BD/DVD VIDEO only)

Your player has a region code printed on the rear of the unit and will only play BD/DVD VIDEO labeled with identical region codes or



# Playable types of files

## Video

Codec	Container	Extension	With Audio
MPEG-1 Video	PS	.mpg, .mpeg	Dolby Digital, DTS, LPCM, MPEG
	MKV	.mkv	Dolby Digital, LPCM, AAC, MP3, Vorbis
MPEG-2 Video	PS	.mpg, .mpeg	Dolby Digital, DTS, LPCM, MPEG
	TS	.m2ts, .mts	Dolby Digital, DTS, LPCM, MPEG, AAC
Xvid	AVI	.avi	Dolby Digital, LPCM, WMA9, MP3
	MKV	.mkv	Dolby Digital, LPCM, AAC, MP3, Vorbis
MPEG4/AVC/ H.264 <sup>*1</sup>	MKV	.mkv	Dolby Digital, LPCM, AAC, MP3, Vorbis
	MP4	.mp4, .m4v	AAC
	TS	.m2ts, .mts	Dolby Digital, DTS, LPCM, MPEG, AAC
	Quick Time	.mov	Dolby Digital, LPCM, AAC, MP3
	FLV	.flv, .f4v	LPCM, AAC, MP3
VC1	3gpp/3gpp2	.3gp, .3g2, .3gpp, .3gp2	AAC
	TS	.m2ts, .mts	Dolby Digital, DTS, LPCM, MPEG, AAC
WMV9 <sup>*2</sup>	MKV	.mkv	Dolby Digital, LPCM, AAC, MP3, Vorbis
	ASF	.wmv, .asf	WMA9, WMA 10 Pro
Motion JPEG	MKV	.mkv	Dolby Digital, LPCM, AAC, MP3, Vorbis
	Quick Time	.mov	Dolby Digital, LPCM, AAC, MP3
HEVC/H.265 <sup>*3</sup>	AVI	.avi	Dolby Digital, LPCM, AAC, MP3
	MKV	.mkv	Dolby Digital, LPCM, AAC, MP3, Vorbis
	MP4	.mp4, .m4v	AAC
VP6	TS	.m2ts, .mts	Dolby Digital, DTS, LPCM, MPEG, AAC
	FLV	.flv	MP3
VP8/VP9	Webm	.webm	Vorbis
	MKV	.mkv	Dolby Digital, LPCM, AAC, MP3, Vorbis

## Format

AVCHD (Ver.2.0)<sup>\*4\*5\*6</sup>

## Music

Codec	Extension
MP3 (MPEG-1 Audio Layer III) <sup>*7</sup>	.mp3
AAC/HE-AAC <sup>*7</sup>	.m4a, .aac
WMA9 Standard	.wma
WMA 10 Pro <sup>*8</sup>	.wma
LPCM <sup>*7</sup>	.wav
FLAC	.flac, .fla
Dolby Digital <sup>*7</sup>	.ac3
DSF	.dsf
DSDIFF <sup>*9</sup>	.dff
AIFF	.aiff, .aif
ALAC	.m4a
Vorbis	.ogg
Monkey's Audio	.ape

## Photo

Format	Extension
JPEG	.jpeg, .jpg, .jpe
PNG	.png <sup>*10</sup>
GIF	.gif <sup>*10</sup>
MPO	.mpo <sup>*11</sup>
BMP	.bmp <sup>*12</sup>
WEBP	.webp

<sup>\*1</sup> The player can support AVC up to Level 5.2.

<sup>\*2</sup> The player can support WMV9 up to Advanced Profile.

<sup>\*3</sup> The player can support HEVC up to Level 5.1.

<sup>\*4</sup> The player can support frame rate up to 60 fps.

<sup>\*5</sup> The player plays AVCHD format files that are recorded on a digital video camera, etc. The AVCHD format disc will not play if it has not been correctly finalised.

<sup>\*6</sup> The player can play AVCHD 3D format.

<sup>\*7</sup> The player can play ".mka" files.

<sup>\*8</sup> The player does not play coded file such as Lossless.

<sup>\*9</sup> The player does not play DST encoded files.

<sup>\*10</sup> The player does not play animated PNG or animated GIF files.

<sup>\*11</sup> For MPO files other than 3D, the key image or the first image is displayed.

<sup>\*12</sup> The player does not support 16bit BMP files.



- Some files may not play depending on the file format, file encoding or recording condition.
- Some files edited on a PC may not play.
- Some files may not be able to perform fast forward or fast reverse function.
- The player does not play coded files such as DRM.
- The player can recognise the following files or folders in BDs, DVDs, CDs and USB devices:
  - up to folders in the 9th layer, including the root folder.
  - up to 500 files/folders in a single layer.
- The player can support frame rate:
  - up to 60 fps for AVCHD (MPEG4/AVC) only.
  - up to 30 fps for other video codecs.
- The player can support video bit rate up to 40 Mbps.
- Some USB devices may not work with this player.
- The player can recognise Mass Storage Class (MSC) devices (such as flash memory or an HDD), Still Image Capture Device (SICD) class devices and 101 keyboard.
- The player may not play high bit rate video and audio files on DATA CDs smoothly. It is recommended to play such files using DATA DVDs or DATA BDs.

# Specifications

Specifications and design are subject to change without notice.

## System

<b>Laser</b>	Semiconductor laser
--------------	---------------------

## Inputs and outputs

<b>Jack name</b>	<b>Jack type/Output level/Load impedance</b>
<b>HDMI OUT</b>	HDMI 19-pin standard connector
<b>LAN (100)</b>	100BASE-TX Terminal
<b>USB</b>	USB jack Type A (For connecting a USB memory, memory card reader, digital still camera, and digital video camera)* * Do not use for power charging purposes.
<b>DC IN</b>	12 V DC, 1.25 A

## General

<b>Power requirements</b>	12 V DC with AC adaptor Rating: Input 220 V – 240 V AC, 50/60 Hz
<b>Power consumption (when using AC adaptor)</b>	15 W
<b>Network standby</b>	Less than 2 W (all wired network ports ON)
<b>Dimensions (approx.)</b>	320 mm × 212 mm × 45 mm (width × depth × height) incl. projecting parts
<b>Mass (approx.)</b>	1.4 kg
<b>Operating temperature</b>	5 °C to 35 °C
<b>Operating humidity</b>	25 % to 80 %

## Copyrights and Trademarks

- Oracle and Java are registered trademarks of Oracle and/or its affiliates. Other names may be trademarks of their respective owners.
- Manufactured under license from Dolby Laboratories. Dolby, Dolby Audio and the double-D symbol are trademarks of Dolby Laboratories.
- For DTS patents, see <http://patents.dts.com>. Manufactured under license from DTS, Inc. DTS, the Symbol, DTS and the Symbol together, Digital Surround, and the DTS 2.0+Digital Out logo, are registered trademarks and/or trademarks of DTS, Inc. in the United States and/or other countries. © DTS, Inc. All Rights Reserved.
- The terms HDMI, HDMI High-Definition Multimedia Interface, Premium High Speed HDMI Cable, and the HDMI Logo are trademarks or registered trademarks of HDMI Licensing Administrator, Inc. in the United States and other countries.
- Blu-ray Disc™, Blu-ray™, BD-Live™, BONUSVIEW™, Ultra HD Blu-ray™ word marks and logos are trademarks of the Blu-ray Disc Association.
- Blu-ray 3D™ and Blu-ray 3D™ logo are trademarks of the Blu-ray Disc Association.
- “DVD Logo” is a trademark of DVD Format/Logo Licensing Corporation.
- “DVD+RW”, “DVD-RW”, “DVD+R”, “DVD-R”, “DVD VIDEO”, “Super Audio CD” and “CD” logos are trademarks.
- “BRAVIA” is a trademark of Sony Corporation.
- MPEG Layer-3 audio coding technology and patents licensed from Fraunhofer IIS and Thomson.
- This product incorporates proprietary technology under license from Verance Corporation and is protected by U.S. Patent 7,369,677 and other U.S. and worldwide patents issued and pending as well as copyright and trade secret protection for certain aspects of such technology. Cinavia is a trademark of Verance Corporation. Copyright 2004-2010 Verance Corporation. All rights reserved by Verance. Reverse engineering or disassembly is prohibited.
- Windows Media is either a registered trademark or trademark of Microsoft Corporation in the United States and/or other countries. This product is protected by certain intellectual property rights of Microsoft Corporation. Use or distribution of such technology outside of this product is prohibited without a license from Microsoft or an authorized Microsoft subsidiary.

Content owners use Microsoft PlayReady™ content access technology to protect their intellectual property, including copyrighted content. This device uses PlayReady technology to access PlayReady-protected content and/or WMDRM-protected content. If the device fails to properly enforce restrictions on content usage, content owners may require Microsoft to revoke the device’s ability to consume PlayReady-protected content. Revocation should not affect unprotected content or content protected by other content access technologies. Content owners may require you to upgrade PlayReady to access their content. If you decline an upgrade, you will not be able to access content that requires the upgrade.

- Vewd® Core. Copyright 1995-2018 Vewd Software AS. All rights reserved.

And right expression:

This software is being provided on an <<as is>> basis.

Vewd and its suppliers disclaim all warranties regarding the software, either express or implied, statutory or otherwise, including without limitation warranties of functionality, fitness for a particular purpose or non-infringement.

- All other trademarks are trademarks of their respective owners.
- Other system and product names are generally trademarks or registered trademarks of the manufacturers.™ and ® marks are not indicated in this document.



## Copy Protection

Please be advised of the advanced content protection systems used in Ultra HD Blu-ray™, Blu-ray Disc™ and DVD media. These systems, called AAC (Advanced Access Content System) and CSS (Content Scramble System), may contain some restrictions on playback, analogue output, and other similar features. The operation of this product and the restrictions placed may vary depending on the date of purchase, as the governing board of the AAC may adopt or change its restriction rules after the time of purchase.

## Cinavia Notice

This product uses Cinavia technology to limit the use of unauthorized copies of some commercially-produced film and videos and their soundtracks. When a prohibited use of an unauthorized copy is detected, a message will be displayed and playback or copying will be interrupted.

More information about Cinavia technology is provided at the Cinavia Online Consumer Information Center at <http://www.cinavia.com>. To request additional information about Cinavia by mail, send a postcard with your mailing address to: Cinavia Consumer Information Center, P.O. Box 86851, San Diego, CA, 92138, USA.

## Software License Information

For EULA (End User License Agreement), please refer to END USER LICENSE AGREEMENT sheet supplied with this player.

### USING YOUR PRODUCT INDICATES YOUR ACCEPTANCE OF THIS AGREEMENT.

For details of the other software licenses, please select  [Setup] on the home screen and refer to [Software License Information] in [System Settings].

This product contains software that is subject to the GNU General Public License ("GPL") or GNU Lesser General Public License ("LGPL"). These licenses establish that customers have the right to acquire, modify, and redistribute the source code of said software in accordance with the terms of the GPL or the LGPL.

The source code for the software used in this product is subject to the GPL and LGPL, and is available on the Web. To download, please visit the following website:

<http://oss.sony.net/Products/Linux>

Please note that Sony cannot respond to any inquiries regarding the content of this source code.

## Language code list

For details, see [BD/DVD Viewing Settings] (page 19).

The language spellings conform to the ISO 639: 1988 (E/F) standard.

Code	Language	Code	Language
1027	Afar	1028	Abkhazian
1032	Afrikaans	1039	Amharic
1044	Arabic	1045	Assamese
1051	Aymara	1052	Azerbaijani
1053	Bashkir	1057	Byelorussian
1059	Bulgarian	1060	Bihari
1061	Bislama	1066	Bengali
1067	Tibetan	1070	Breton
1079	Catalan	1093	Corsican
1097	Czech	1103	Welsh
1105	Danish	1109	German
1130	Bhutani; Dzongkha	1142	Greek
1144	English	1145	Esperanto
1149	Spanish	1150	Estonian
1151	Basque	1157	Persian
1165	Finnish	1166	Fiji
1171	Faroese	1174	French
1181	Frisian	1183	Irish
1186	Scots Gaelic	1194	Galician
1196	Guarani	1203	Gujarati
1209	Hausa	1217	Hindi
1226	Croatian	1229	Hungarian
1233	Armenian	1235	Interlingua
1239	Interlingue	1245	Inupiak
1248	Indonesian	1253	Icelandic
1254	Italian	1257	Hebrew
1261	Japanese	1269	Yiddish
1283	Javanese	1287	Georgian
1297	Kazakh	1298	Greenlandic; Kalaallisut
1299	Cambodian; Khmer	1300	Kannada
1301	Korean	1305	Kashmiri
1307	Kurdish	1311	Kirghiz
1313	Latin	1326	Lingala
1327	Laothian; Lao	1332	Lithuanian
1334	Latvian	1345	Malagasy
1347	Maori	1349	Macedonian
1350	Malayalam	1352	Mongolian
1353	Moldavian	1356	Marathi
1357	Malay	1358	Malese; Maltese
1363	Burmese	1365	Nauru
1369	Nepali	1376	Dutch

Code	Language	Code	Language
1379	Norwegian	1393	Occitan
1403	Oromo	1408	Oriya
1417	Punjabi; Panjabi	1428	Polish
1435	Pashto; Pushto	1436	Portuguese
1463	Quechua	1481	Rhaeto- Romance
1482	Kirundi; Rundi	1483	Romanian
1489	Russian	1491	Kinyarwanda
1495	Sanskrit	1498	Sindhi
1501	Sangho; Sango	1502	Serbo- Croatian
1503	Singhalese; Sinhalese	1505	Slovak
1506	Slovenian	1507	Samoaan
1508	Shona	1509	Somali
1511	Albanian	1512	Serbian
1513	Siswati; Swati	1514	Sesotho; Sotho southern
1515	Sundanese	1516	Swedish
1517	Swahili	1521	Tamil
1525	Telugu	1527	Tajik
1528	Thai	1529	Tigrinya
1531	Turkmen	1532	Tagalog
1534	Setswana; Tswana	1535	Tonga; Tonga islands
1538	Turkish	1539	Tsonga
1540	Tatar	1543	Twi
1557	Ukrainian	1564	Urdu
1572	Uzbek	1581	Vietnamese
1587	Volapük	1613	Wolof
1632	Xhosa	1665	Yoruba
1684	Chinese	1697	Zulu
1703	Not specified		

## Parental control/area code

For details, see [Parental Control Area Code] (page 20).

<b>Code</b>	<b>Area</b>		
2044	Argentina	2047	Australia
2046	Austria	2057	Belgium
2070	Brazil	2090	Chile
2092	China	2093	Colombia
2115	Denmark	2165	Finland
2174	France	2109	Germany
2200	Greece	2219	Hong Kong
2248	India	2238	Indonesia
2239	Ireland	2254	Italy
2276	Japan	2304	Korea
2333	Luxembourg	2363	Malaysia
2362	Mexico	2376	Netherlands
2390	New Zealand	2379	Norway
2427	Pakistan	2424	Philippines
2428	Poland	2436	Portugal
2489	Russia	2501	Singapore
2149	Spain	2499	Sweden
2086	Switzerland	2543	Taiwan
2528	Thailand	2184	United Kingdom
2586	Vietnam		









## For Your Convenience

### Before Inquiries

Please confirm the following details:

- Investigate with "Troubleshooting" (page 22) to help remedy the problem.
- Turn off the player and disconnect the AC power cord (mains lead). Wait for more than 30 seconds and then reconnect the AC power cord (mains lead).

Record the serial number (S/N) in the space provided below. Provide this number to your Sony dealer to get quicker action whenever you call them regarding this product.

S/N \_\_\_\_\_



To find out useful hints, tips and information about Sony products and services please visit: [www.sony.eu/myproducts/](http://www.sony.eu/myproducts/)

4-738-236-12(2)

<http://www.sony.net/>

© 2018 Sony Corporation

Printed in Malaysia

